

PowerFlex DC Drive and Field Controller

Catalog Numbers 20P, 23P, 23PFC



Topic	Page
Summary of Changes	2
Additional Resources	2
The PowerFlex® DC Drive	3
The PowerFlex DC Field Controller	5
The PowerFlex DC Standalone Regulator	6
Unsurpassed Capability in Network Communication	5
PowerFlex DC Drive Catalog Number Explanation	6
PowerFlex DC Field Controller Catalog Number Explanation	7
PowerFlex DC Field Controller Product Selection	7
Factory-installed Options	8
User-installed Options	8
Isolation Transformers	10
Installation Considerations	20
Typical Power Wiring Diagrams	23
PowerFlex DC Drives Terminal Block Locations	29
PowerFlex DC Drives and Field Controller Circuit Protection	47
Mounting	60



Topic	Page
Approximate Dimensions – PowerFlex DC Drives	62
Approximate Dimensions and Weights – PowerFlex DC Field Controllers	68
PowerFlex DC Drive Specifications	70
PowerFlex DC Field Controller Specifications	73
IP20 NEMA/UL Type Open Watts Loss	74

Summary of Changes

This publication contains new and updated information as indicated in the following table.

Topic	Page
Removed Compact I/O™ to DIP/SCANport module, Serial null modem adapter, and Smart self-powered serial converter (RS-232) from Communication Option Kits table in User-installed Options section.	9
Added Overvoltage Protection Devices table to the User-installed Options section.	9
Added Voltage Clamp Kits and Dampening Resistor (RB) Kit Selection tables.	9
Removed the Isolation Transformers for 200V AC Input Field Controllers table from the Isolation Transformers section.	10
Replaced the PowerFlex DC Drive Power Wiring with DC Output Contactor graphic in the Typical Power Wiring Diagrams section.	25
Changed the Factory Default in Terminal Block 1 from 1 “Volt Ref A” to 5 “Current Ref” in the I/O Terminal Block 1 Designations table.	42
Restored Frame A and B Armature DC Output Fuses tables.	48

Additional Resources

These documents contain more information on related products from Rockwell Automation®.

Resource	Description
PowerFlex Digital DC Drive User Manual, publication 20P-UM001	Provides basic information that is required to install, start up, and troubleshoot the PowerFlex DC drive.
PowerFlex DC Field Controller Installation Instructions, publication 23PFC-IN001	Provides installation instructions for the PowerFlex DC field controller.
PowerFlex DC Fiber-optic Interface Option Module Installation Instructions, publication 20P-IN078	Provides installation instructions for the PowerFlex DC fiber-optic interface module.
PowerFlex DC Field Controller Programming Manual, publication 23PFC-PM001	Provides information on how to start up, program, and troubleshoot the PowerFlex DC field controller.
PowerFlex Digital DC Drive - Frame A Hardware Service Manual, publication 20P-TG001	Provides hardware test procedures and spare parts replacement instructions for Frame A PowerFlex DC drives and field controllers.
PowerFlex Digital DC Drive - Frame B Hardware Service Manual, publication 20P-TG002	Provides hardware test procedures and spare parts replacement instructions for Frame B PowerFlex DC drives and field controllers.
A Global Reference Guide for Reading Schematic Diagrams, publication 100-2.10	Provides a simple cross-reference of common schematic/wiring diagram symbols that are used throughout various parts of the world.
Guarding Against Electrostatic Damage, publication 8000-4.5.2	Explains the causes of electrostatic damage (ESD) and how to guard against its effects.
Preventive Maintenance of Industrial Control and Drive System Equipment, publication DRIVES-TD001	Provides a recommended preventative maintenance checklist.

Resource	Description
Safety Guidelines for the Application, Installation, and Maintenance of Solid-state Control, publication SG1-1.1	Provides general guidelines for the application, installation, and maintenance of solid-state control in the form of individual devices or packaged assemblies that incorporate solid-state components.
Industrial Automation Wiring and Grounding Guidelines, publication 1770-4.1	Provides general guidelines for installing a Rockwell Automation® industrial system.
Product Certifications website, https://www.rockwellautomation.com/global/certification/overview.page?	Provides declarations of conformity, certificates, and other certification details.

You can view or download publications at <http://www.rockwellautomation.com/literature/>. To order paper copies of technical documentation, contact your local Allen-Bradley distributor or Rockwell Automation sales representative.

For other information, contact Allen-Bradley® Drives Technical Support at <http://www.ab.com/support/abdrives>.

The PowerFlex® DC Drive

The PowerFlex® DC drive (20P) provides digital control for precise speed and current regulation, easy programmability, extensive diagnostics, and non-regenerative or regenerative operation. PowerFlex DC drives can run various applications, including extruder operations, finishing, drawing, and coating. The PowerFlex DC drive can effectively control applications that exhibit shock loads, high inertia, rapid acceleration and deceleration rates, or continuous regeneration. These features of the PowerFlex DC drive make it an excellent choice for existing DC machinery upgrades. The compact design of this drive includes a fully contained power module and a common control structure for the entire range of horsepower. And, to make connectivity even easier, the PowerFlex DC drive provides a standard DPI™ interface that is compatible with all PowerFlex DPI communication products.

The standard hardware consists of an open type enclosure, armature converter, regulated field converter for field weakening or economy applications, and an advanced regulator with integrated DPI functionality. The standard I/O includes eight digital inputs, four digital outputs, three analog inputs, two analog outputs, a DC tachometer, and encoder capability.

Optional I/O and feedback modules are available and are sold separately from the standard hardware offering. For more information, see [I/O Option Kits](#) and [Feedback Option Kit \(only for PowerFlex DC drives\)](#) on [page 8](#).

Drive Features

- Fast-acting **Current Limit** and **Voltage Regulation** result in maximum accelerate/decel without tripping.
- **High-speed analog inputs** improve drive response to torque or speed commands.
- **Programming flexibility** allows parameters to be linked within the drive.
- **Field-flashable firmware** through DPI interface.
- **Flying Start** delivers smooth and instantaneous connection into a rotating load, regardless of commanded direction, without the need for any speed feedback.
- **Single-phase Regulated Field supply** (10 A, 14 A, 20 A, 40 A, and 70 A, depending on the drive size) standard on all frames.
- **Integral Process PI Control** replaces the need for a separate controller for a process loop.
- **TorqProve™** helps assure control of the load when control is transferred between the drive and a mechanical brake.
- **Speed Regulation** - open-loop or closed-loop
 - Armature Feedback provides a 2000:1 rpm speed range
 - DC Tachometer Feedback provides up to 0.1% speed regulation
 - Encoder Feedback provides up to 0.1% speed regulation for the tightest application requirements.
- **Torque Regulation** - open-loop or closed-loop
 - Open-loop torque regulation provides ±5% regulation.
 - Encoder Feedback provides ±1% regulation and the ability to hold full load at zero speed.

Packaging and Mounting

- **IP20, NEMA/UL Type Open** - For conventional mounting inside or outside a control cabinet.

Communication Tools

The PowerFlex DC drive and field controller provide common communication tools that are familiar and easy to use, including the LCD Human Interface Module (HIM) and PC-based configuration tools.

- The LCD HIM provides:
 - Large and easy to read 7 line x 21 character, backlit display
 - Alternate function keys for shortcuts to common tasks
 - ‘Calculator-like’ number pad for fast and easy data entry (full numeric version only)
 - Control keys for local start, stop, speed, and direction
 - Remote versions for panel mount applications
- PC-based configuration tools include:
 - Connected Components Workbench™ (CCW) software v2.0. This software leverages proven Rockwell Automation and Microsoft® Visual Studio® technologies for drive configuration and programming. CCW software can be downloaded for free from <https://www.rockwellautomation.com/global/support/connected-components/workbench.page?>
 - DriveTools™ SP (v4.01 or higher is required with a PowerFlex DC drive specific software patch. The patch can be downloaded from <https://compatibility.rockwellautomation.com/Pages/home.aspx>. A suite of software tools that provide an intuitive way to program, troubleshoot, and maintain Allen-Bradley drives, including the PowerFlex DC Drive Startup Wizard.
- Internal communications allow you to integrate the drive and/or field controller into the manufacturing process. Status indicators for all internal communication options are visible on the cover for easy setup and monitoring of drive communications. You can easily manage information from ‘shop floor to top floor’ and seamlessly integrate a complete system as you control, configure, and collect data.

The PowerFlex DC Field Controller

The PowerFlex DC Field Controller provides three-phase, four quadrant (reversing) DC motor or generator field control. The PowerFlex DC Field Controller can be used for standalone DC motor field control applications, or with a PowerFlex DC Digital drive or PowerFlex DC Standalone Regulator (SAR). A fiber-optic interface option module, or digital and analog I/O, provides transmission of the reference, feedback, and status signals between the drive or regulator and the field controller.

In the standalone mode, the PowerFlex DC Field Controller provides power to a DC motor field with a fixed reference by using fixed I/O. The PowerFlex DC Field Controller can also be used to supply various DC non-motor loads (highly inductive loads). These DC non-motor loads include galvanic applications, electromagnets, synchronous motor excitation circuits, and others.

A PowerFlex DC field controller is a cost-effective way to modernize DC motor controls while using/re-purposing existing equipment.

Controller Features

- **Programming flexibility** allows parameters to be linked within the device.
- **Field-flashable firmware** through DPI interface.
- **Reversing field supply** standard on all frames.
- **Control non-motor inductive loads**, such as electromagnets

The PowerFlex DC Standalone Regulator

The PowerFlex DC Standalone Regulator (SAR) and Gate Amplifier products provide an integrated solution to control external DC power modules. The SAR is a DC drive regulator that provides armature regulation, armature SCR gate signals and a regulated field supply. The SAR field supply consists of a single-phase, two quadrant (non-reversing) full wave rectified bridge, available as 40 amps or 70 amps. The SAR supports an AC line input voltage range of 230...690V AC and a field input voltage range of 100...460V AC.

Unsurpassed Capability in Network Communication

PowerFlex DC products are fully compatible with the wide variety of Allen-Bradley DPI communication adapters, which offer the following benefits:

BACnet	ControlNet	DeviceNet	EtherNet/IP	PROFIBUS	RS-485 DF1	Description
√	√	√	√			(Unconnected Messaging) permits other network devices (for example PanelView™) to communicate directly to a drive without routing the communication through the network scanner.
√	√	√	√		√	Adapter Routing - Plug personal computer into one drive and talk to all other Allen-Bradley drives on same network, without being routed through network scanner.
√	√	√	√	√	√	Access to 100% of all parameters over the network.
√		√	√	√		Autobaud capability makes initial connections less problematic.
		√				Change of State significantly reduces network traffic by configuring control messages to be sent only upon customer defined states. Flexible configuration for each node (Example: "reference must change by more than 5%").
		√	√			Peer Control provides master-slave type control between drives. With this feature, one or more slave drives (consumers) can run based on the status of a master drive (producer). This feature can significantly reduce network traffic.
		√				ADR (Automatic Device Replacement) saves significant time and effort when replacing a drive. The scanner can be configured to detect a new drive and download the required parameter settings.
√	√	√	√	√	√	Flexible Fault Configuration - Adapters can be programmed to take fault-based actions, such as Ramp to Stop, and send user-configurable logic control and speed reference values. The drive can take different actions that are based on whether the network experienced a serious problem (broken cable, for example) versus network idle condition (PLC set to "Program").

PowerFlex DC Drive Catalog Number Explanation

1...3	4	5	6	7	8...10	11	12	13	14	15	16
20P	4	1	A	D	4P1	R	A	0	N	N	N
a	b	c	d	e	f	g	h	i	j	k	l

a	
Drive	
Code	Type
20P	PowerFlex DC drive
b	
Motor Operation	
Code	Type
2	Two quadrant operation ⁽¹⁾
4	Four quadrant operation
c	
Input Type	
Code	Type
1	6 pulse
d	
Enclosure	
Code	Enclosure Rating
A	IP20, NEMA/UL Type Open ⁽¹⁾
e	
Input Voltage	
Code	Voltage
B	230V AC
D	460V AC ⁽¹⁾
E	600V AC
F	690V AC

(1) Use this code for 400V AC input applications.

f1					
230V, 60 Hz Input					
Code	Hp	kW	Armature Amps	Frame	Field Amps
7P0	1.5	1.2	7	A	10
9P0	2	1.5	9		
012	3	2.2	12		
020	5	3.7	20		
029	7.5	5.5	29		
038	10	7.5	38		
055	15	11	55		
073	20	15	73		
093	25	18.5	93		
110	30	22	110		
146	40	30	146	B	20
180	50	37	180		
218	60	45	218		
265	75	56	265		
360	100	75	360		
434	125	93	434		
521	150	112	521		
700	200	149	700		
875	250	186	875		
1K0	300	224	1050		
				C	40
				D	

f2					
460V, 60 Hz Input					
Code	Hp	kW	Armature Amps	Frame	Field Amps
4P1	2	1.5	4.1	A	10
6P0	3	2.2	6		
010	5	3.7	10		
014	7.5	5.5	14		
019	10	7.5	19		
027	15	11	27		
035	20	15	35		
045	25	18.5	45		
052	30	22	52		
073	40	30	73		
086	50	37	86	B	14
100	60	45	100		
129	75	56	129		
167	100	75	167		
207	125	93	207		
250	150	112	250		
330	200	149	330		
412	250	187	412		
495	300	224	495		
667	400	298	667		
830	500	373	830	C	20
996	600	447	996		
1K1	700	552	1162		
1K3	800	597	1328		
1K4	900	671	1494		
				D	40
				D	70

f3					
575V, 60 Hz Input					
Code	Hp	kW	Armature Amps	Frame	Field Amps
067	50	37	67.5	B	20
101	75	56	101.3		
135	100	75	135		
270	200	149	270		
405	300	224	405		
540	400	298	540		
675	500	373	675		
810	600	447	810		
1K0	800	597	1080		
1K2	900	671	1215		
1K3	1000	746	1350	D	40
1K6	1250	932	1668		

f4					
690V, 60 Hz Input					
Code	Hp	kW	Armature Amps	Frame	Field Amps
452	400	298	452	C	20
565	500	373	565		
678	600	447	678		
791	700	552	791	D	40
904	800	597	904		
1K0	900	671	1017		
1K1	1000	746	1130		
1K2	1100	820	1243		
1K4	1250	932	1413		
1K5	1400	1044	1582		

g	
Field Supply	
Code	Type
R	Single-phase regulated
h	
Packaging/Documentation	
Code	Type
A	Shipping carton and user manual
i	
HIM	
Code	Operator Interface
0	Blank cover ⁽¹⁾

(1) Standard; for user installed options, see [Human Interface Modules on page 8](#).

j	
I/O Options ⁽¹⁾	
Code	Control
N	None ⁽²⁾

(1) All I/O options are purchased separately and user installed. See [I/O Option Kits on page 8](#).

(2) Eight 24V DC digital inputs, four digital outputs, three analog inputs, and two analog outputs are standard.

k	
Communication Options	
Code	Description
N	None ⁽¹⁾

(1) Standard; for user installed options, see [Communication Option Kits on page 9](#).

l	
Cabinet Options	
Code	Type
N	None

PowerFlex DC Field Controller Catalog Number Explanation

POSITION
 1...5 6 7...9
23PFC **B** **245**
a b c

a		b		c	
Drive		Input Voltage		DC Output	
Code	Type	Code	Voltage Range/Phase	Code	Amps
23PFC	PowerFlex DC field controller	B	60...200V AC ($\pm 10\%$) / 3	017	17
		D	230...500V AC ($\pm 10\%$) / 3	060	60
				120	120
				245	245
				365	365
				570	570

PowerFlex DC Field Controller Product Selection

All PowerFlex DC field controllers are conformal coated.

IP20, NEMA/UL Type Open – 60...200V AC, Three-Phase, 50/60 Hz

Input, V AC	DC Output, amps	Cat. No.	Frame Size
60...200	17	23PFCB017	A
	60	23PFCB060	
	120	23PFCB120	
	245	23PFCB245	B
	365	23PFCB365	
	570	23PFCB570	

IP20, NEMA/UL Type Open – 230...500V AC, Three-Phase, 50/60 Hz

Input, V AC	DC Output, amps	Cat. No.	Frame Size
230...500	17	23PFCD017	A
	60	23PFCD060	
	120	23PFCD120	
	245	23PFCD245	B
	365	23PFCD365	
	570	23PFCD570	

Factory-installed Options

Each PowerFlex DC drive includes one encoder and DC analog tachometer input. No other factory-installed options are currently available for PowerFlex DC drives and field controllers.

User-installed Options

Unless otherwise specified, these user installed options are available for PowerFlex DC drives and field controllers.

Human Interface Modules

Description	Handheld/ Local Drive Mount	Remote (Panel Mount) IP66, NEMA/UL Type 4x/12 ⁽¹⁾
	Cat. No.	Cat. No.
No HIM (blank plate)	20-HIM-A0	—
LCD display, full numeric keypad	20-HIM-A3	20-HIM-CS3 ⁽²⁾
LCD display, programmer only	20-HIM-A5	20-HIM-CS5 ⁽²⁾
Enhanced LCD, full numeric keypad	20-HIM-A6	20-HIM-CS6 ⁽²⁾

(1) Only for indoor use.

(2) Includes a 1202-C30 interface cable (3 m) for connection to drive.

Human Interface Module Accessories

Description	Cat. No.
Bezel kit for LCD HIMs, NEMA/UL Type 1 ⁽¹⁾	20-HIM-B1
PowerFlex HIM interface cable, 1 m (39 in.) ⁽²⁾	20-HIM-H10
Cable kit (male-female) ⁽³⁾	1202-H03 1202-H10 1202-H30 1202-H90
DPI/SCANport™ 1-to-2 port splitter cable	1203-S03

(1) Includes a 1202-C30 interface cable (3 m) for connection to drive.

(2) Required only when HIM is used as a handheld or remote.

(3) Required in addition to 20-HIM-H10 for distances up to a total maximum of 10 m (32.8 ft).

I/O Option Kits

Description	Cat. No.
I/O expansion board ⁽¹⁾	20P-S5V62
115V AC to 24V DC eight-channel I/O converter board ⁽²⁾	20P-S520L

(1) Has four 24V DC digital inputs, four digital outputs, and two analog outputs.

(2) Converts eight digital inputs.

Feedback Option Kit (only for PowerFlex DC drives)

Description	Cat. No.
Resolver feedback option module	20P-RES-A0



User-installed Options, Continued

Communication Option Kits

Description	Cat. No.
BACnet® MS/TP RS-485 communication adapter	20-COMM-B
ControlNet™ communication adapter (coaxial)	20-COMM-C
DeviceNet™ communication adapter	20-COMM-D
EtherNet/IP™ communication adapter	20-COMM-E
Dual-port EtherNet/IP™ communication adapter	20-COMM-ER
HVAC communication adapter	20-COMM-H
Modbus/TCP communication adapter	20-COMM-M
PROFIBUS™ DP communication adapter	20-COMM-P
ControlNet™ communication adapter (fiber)	20-COMM-Q
RS-485 DF1 communication adapter	20-COMM-S
External communications kit power supply	20-XCOMM-AC-PS1
External DPI communications kit	20-XCOMM-DC-BASE
External DPI I/O option board ⁽¹⁾	20-XCOMM-IO-OPT1
USB converter ⁽²⁾	1203-USB

(1) For use only with external DPI communications kits 20-XCOMM-DC-BASE.

(2) Includes 2 m USB, 20-HIM-H10, and 22-HIM-H10 cables.

Personal Computer Programming Software

Description	Cat. No.
Connected Components Workbench™ (CCW)	(1)
DriveTools™ SP software	(2)
Studio 5000® environment	(3)

(1) Download available for free at <http://www.rockwellautomation.com/global/support/connected-components/workbench.page?>

(2) Available to order through the 'How to Buy' link at <http://ab.rockwellautomation.com/Drives/Software/9303-DriveTools-SP#overview>.

(3) For more information on the Studio 5000 environment, see <http://www.rockwellautomation.com/rockwellsoftware/products/studio-5000.page>.

Fiber-optic Kits

Fiber-optic card is not required. It can be used for communication between a PowerFlex DC drive and field controller. For more information on fiber-optic cards, see publication [20P-IN078](#).

PowerFlex DC Fiber-optic Interface Option Module Installation Instructions.

Description	Cat. No.
Fiber-optic card	20P-S5H781
Fiber-optic cable kit <ul style="list-style-type: none"> • 3 m (9.8 ft) • 5 m (16.4 ft) 	SK-20P-2950 SK-20P-29501

Overvoltage Protection Devices

When the PowerFlex DC Field Controller is used to supply a very inductive load like a motor/generator field or an electromagnet, an overvoltage protection device (voltage clamp) and dampening resistor must be installed on the field controller load. See the PowerFlex DC Field Controller Voltage Clamp Installation Instructions, publication [23PFC-IN002](#), for details. These tables identify the voltage clamp and dampening resistor kits.

Voltage Clamp Kits

Field Controller Specifications			Voltage Clamp Cat. No.
AC Input Voltage	Output Amp Rating	Frame Size	
200	17...120	A	23P-FCOVPD-B-FA
200	245...570	B	23P-FCOVPD-B-FB
500	17...120	A	23P-FCOVPD-D-FA
500	245...570	B	23P-FCOVPD-D-FB

Dampening Resistor (RB) Kit Selection

Field Controller AC Input Voltage Range (Vrms)	RB Resistor Value Ohms	RB Resistor Size Watts	RB Resistor Kit Cat. No. ⁽¹⁾
60...100V	220	930	23P-FC-RB100
101...200V	390	930	23P-FC-RB200
201...300V	680	930	23P-FC-RB300
301...400V	1000	930	23P-FC-RB400
401...500V	1200	930	23P-FC-RB500

(1) Resistor kits are IP00 / Open Type and must be installed in an enclosure.

Isolation Transformers

Isolation transformers are available for installations that have specific types of AC supply configurations or require drive protection due to AC line disturbances.

A customer-supplied 200V AC Three Phase Secondary Isolation Transformer must be installed with a 200V AC PowerFlex DC field controller.

PowerFlex DC Drive Isolation Transformers

Three Phase Primary Voltage			Three Phase Secondary Voltage		
kVA	kW (Hp)	Voltage	230V AC Cat. No.	460V AC Cat. No.	575V AC Cat. No.
5	1.2...2.2 (1.5...3)	230	—	1321-3TW005-AB	
		460	1321-3TW005-BA	1321-3TW005-BB	
		575	1321-3TW005-CA	1321-3TW005-CB	
7.5	3.7 (5)	230	1321-3TW007-AA	1321-3TW007-AB	
		460	1321-3TW007-BA	1321-3TW007-BB	
		575	1321-3TW007-CA	1321-3TW007-CB	
11	5.5 (7.5)	230	1321-3TW011-AA	1321-3TW011-AB	
		460	1321-3TW011-BA	1321-3TW011-BB	
		575	1321-3TW011-CA	1321-3TW011-CB	
14	7.5 (10)	230	1321-3TW014-AA	1321-3TW014-AB	
		460	1321-3TW014-BA	1321-3TW014-BB	
		575	1321-3TW014-CA	1321-3TW014-CB	
20	11 (15)	230	1321-3TW020-AA	1321-3TW020-AB	—
		460	1321-3TW020-BA	1321-3TW020-BB	
		575	1321-3TW020-CA	1321-3TW020-CB	
27	15 (20)	230	1321-3TW027-AA	1321-3TW027-AB	
		460	1321-3TW027-BA	1321-3TW027-BB	
		575	1321-3TW027-CA	1321-3TW027-CB	
34	18.5 (25)	230	1321-3TW034-AA	1321-3TW034-AB	
		460	1321-3TW034-BA	1321-3TW034-BB	
		575	1321-3TW034-CA	1321-3TW034-CB	
40	22 (30)	230	1321-3TW040-AA	1321-3TW040-AB	
		460	1321-3TW040-BA	1321-3TW040-BB	
		575	1321-3TW040-CA	1321-3TW040-CB	
51	30 (40)	230	1321-3TW051-AA	1321-3TW051-AB	
		460	1321-3TW051-BA	1321-3TW051-BB	
		575	1321-3TW051-CA	1321-3TW051-CB	
63	37 (50)	230	1321-3TH063-AA	1321-3TH063-AB	1321-3TH063-AC
		460	1321-3TH063-BA	1321-3TH063-BB	1321-3TH063-BC
		575	1321-3TH063-CA	1321-3TH063-CB	1321-3TH063-CC
75	45 (60)	230	1321-3TH075-AA	1321-3TH075-AB	1321-3TH075-AC
		460	1321-3TH075-BA	1321-3TH075-BB	1321-3TH075-BC
		575	1321-3TH075-CA	1321-3TH075-CB	1321-3TH075-CC

PowerFlex DC Drive Isolation Transformers (continued)

Three Phase Primary Voltage			Three Phase Secondary Voltage		
kVA	kW (Hp)	Voltage	230V AC Cat. No.	460V AC Cat. No.	575V AC Cat. No.
93	56 (75)	230	1321-3TH093-AA	1321-3TH093-AB	1321-3TH093-AC
		460	1321-3TH093-BA	1321-3TH093-BB	1321-3TH093-BC
		575	1321-3TH093-CA	1321-3TH093-CB	1321-3TH093-CC
118	75 (100)	230	1321-3TH118-AA	1321-3TH118-AB	1321-3TH118-AC
		460	1321-3TH118-BA	1321-3TH118-BB	1321-3TH118-BC
		575	1321-3TH118-CA	1321-3TH118-CB	1321-3TH118-CC
145	93 (125)	230	1321-3TH145-AA	1321-3TH145-AB	1321-3TH145-AC
		460	1321-3TH145-BA	1321-3TH145-BB	1321-3TH145-BC
		575	1321-3TH145-CA	1321-3TH145-CB	1321-3TH145-CC
175	112 (150)	230	1321-3TH175-AA	1321-3TH175-AB	1321-3TH175-AC
		460	1321-3TH175-BA	1321-3TH175-BB	1321-3TH175-BC
		575	1321-3TH175-CA	1321-3TH175-CB	1321-3TH175-CC
220	145 (200)	230	1321-3TH220-AA	1321-3TH220-AB	1321-3TH220-AC
		460	1321-3TH220-BA	1321-3TH220-BB	1321-3TH220-BC
		575	1321-3TH220-CA	1321-3TH220-CB	1321-3TH220-CC
275	187 (250)	230	1321-3TH275-AA	1321-3TH275-AB	1321-3TH275-AC
		460	1321-3TH275-BA	1321-3TH275-BB	1321-3TH275-BC
		575	1321-3TH275-CA	1321-3TH275-CB	1321-3TH275-CC
330	224 (300)	230	1321-3TH330-AA	1321-3TH330-AB	1321-3TH330-AC
		460	1321-3TH330-BA	1321-3TH330-BB	1321-3TH330-BC
		575	1321-3TH330-CA	1321-3TH330-CB	1321-3TH330-CC
440	298 (400)	230	—	1321-3TH440-AB	1321-3TH440-AC
		460		1321-3TH440-BB	1321-3TH440-BC
		575		1321-3TH440-CB	1321-3TH440-CC
550	373 (500)	230		1321-3TH550-AB	1321-3TH550-AC
		460		1321-3TH550-BB	1321-3TH550-BC
		575		1321-3TH550-CB	1321-3TH550-CC
660	448 (600)	230		1321-3TH660-AB	1321-3TH660-AC
		460		1321-3TH660-BB	1321-3TH660-BC
		575		1321-3TH660-CB	1321-3TH660-CC
770	522 (700)	230		1321-3TH770-AB	1321-3TH770-AC
		460		1321-3TH770-BB	1321-3TH770-BC
		575		1321-3TH770-CB	1321-3TH770-CC
880	597 (800)	230		1321-3TH880-AB	1321-3TH880-AC
		460		1321-3TH880-BB	1321-3TH880-BC
		575		1321-3TH880-CB	1321-3TH880-CC

PowerFlex DC Field Controller Isolation Transformers – 500V AC Input

Three Phase Primary Voltage		460V AC Three Phase Secondary
kVA	Voltage	Isolation Transformer Cat. No.
14	230	1321-3TW014-AB
	460	1321-3TW014-BB
	575	1321-3TW014-CB
51	230	1321-3TW051-AB
	460	1321-3TW051-BB
	575	1321-3TW051-CB
93	230	1321-3TH093-AB
	460	1321-3TH093-BB
	575	1321-3TH093-CB
175	230	1321-3TH175-AB
	460	1321-3TH175-BB
	575	1321-3TH175-CB
275	230	1321-3TH275-AB
	460	1321-3TH275-BB
	575	1321-3TH275-CB
440	230	1321-3TH440-AB
	460	1321-3TH440-BB
	575	1321-3TH440-CB

AC Input Line Reactors and Contactors

If a DC contactor is used, an AC input contactor is not needed.

PowerFlex DC Drives – 230V AC Input

Frame	Drive Current Rating Code	DC amps	AC Line amps	Hp	IP00 (Open Style) Line Reactor Cat No.	Line Reactor kW (Hp)	AC Input Contactor Cat. No.
A	7P0	7	5.7	1.5	1321-3R8-A	0.75 (1)	100-C12D10
	9P0	9	7.4	2	1321-3R12-A	1.49 (2)	100-C12D10
	012	12	9.8	3	1321-3R18-A	0.75...3.7 (1...5)	100-C12D10
	020	20	16	5	1321-3R18-A		100-C23D10
	029	29	24	7.5	1321-3R55-A	5.5...11 (7.5...15)	100-C30D10
	038	38	31	10	1321-3R55-A		100-C37D10
	055	55	45	15	1321-3R55-A		100-C60D10
	073	73	60	20	1321-3R80-A	15 (20)	100-C60D10
	093	93	76	25	1321-3R100-A	18.5...22 (25...30)	100-C85D10
	110	110	90	30	1321-3R100-A		100-D110D11

Frame	Drive Current Rating Code	DC amps	AC Line amps	Hp	IPO0 (Open Style) Line Reactor Cat No.	Line Reactor kW (Hp)	AC Input Contactor Cat. No.
B	146	146	119	40	1321-3R160-A	30...37 (40...50)	100-D140D11
	180	180	147	50	1321-3R160-A		100-D180D11
	218	218	178	60	1321-3RB250-A	45...56 (60...75)	100-D180D11
	265	265	217	75	1321-3RB250-A		100-D250ED11
	360	360	294	100	1321-3RB320-A	75 (100)	100-D300ED11
	434	434	355	125	1321-3RB400-A	93 (125)	100-D420ED11
C	521	521	426	150	1321-3R500-A	112 (150)	100-D630ED11
	700	700	572	200	1321-3R600-A	149 (200)	100-D630ED11
D	875	875	715	250	1321-3R750-A	186 (250)	100-D860ED11
	1K0	1050	858	300	1321-3R850-A	224 (300)	100-D860ED11

PowerFlex DC Drives – 460V AC Input

Frame	Drive Current Rating Code	DC amps	AC Line amps	Hp	IPO0 (Open Style) Line Reactor Cat No.	Line Reactor kW (Hp)	AC Input Contactor Cat. No.
A	4P1	4.1	3.3	2	1321-3R4-A	0.55 (0.75)	100-C12D10
	6P0	6	4.9	3	1321-3R8-A	0.75 (1)	100-C12D10
	010	10	8.2	5	1321-3R18-B	1.5...7.5 (2...10)	100-C12D10
	014	14	11.4	7.5	1321-3R18-B		100-C12D10
	019	19	15.5	10	1321-3R18-B		100-C23D10
	027	27	22.1	15	1321-3R55-B	11...22 (15...30)	100-C23D10
	035	35	28.6	20	1321-3R55-B		100-C30D10
	045	45	36.8	25	1321-3R55-B		100-C37D10
	052	52	42.5	30	1321-3R55-B		100-C43D10
	073	73	59.6	40	1321-3R80-B	30 (40)	100-C60D10
	086	86	70.3	50	1321-3R100-B	37...45 (50...60)	100-C85D10
	100	100	81.7	60	1321-3R100-B		100-C85D10
	129	129	105.4	75	1321-3R160-B	56...75 (75...100)	100-D110D11
	167	167	136.4	100	1321-3R160-B		100-D140D11
B	207	207	169.1	125	1321-3RB250-B	93...112 (125...150)	100-D180D11
	250	250	204.3	150	1321-3RB250-B		100-D210ED11
	330	330	269.6	200	1321-3RB320-B	149 (200)	100-D300ED11
	412	412	336.6	250	1321-3RB400-B	186.4 (250)	100-D420ED11
C	495	495	404.4	300	1321-3R500-B	223.7 (300)	100-D420ED11
	667	667	544.9	400	1321-3R600-B	298.3 (400)	100-D630ED11
D	830	830	678.1	500	1321-3R750-B	372.8 (500)	100-D860ED11
	996	996	813.7	600	1321-3R850-B	447.4 (600)	100-D860ED11
	1K1	1162	949.4	700	1321-3R1000-B	552 (700)	100-G860KD22
	1K3	1328	1085.0	800	2 x1321-3R600-B	596.6 (800)	100-G860KD22
	1K4	1494	1220.6	900	2 x1321-3R600-B	671.1 (900)	100-G1200KD12

PowerFlex DC Drives – 575V AC Input

Frame	Drive Current Rating Code	DC amps	AC Line amps	Hp	IP00 (Open Style) Line Reactor Cat No.	Line Reactor kW (Hp)	AC Input Contactor Cat. No.
B	067	67.5	55.1	50	1321-3R55-B	37 (50)	100-C60D10
	101	101.25	82.7	75	1321-3R100-B	56 (75)	100-C85D10
	135	135	110.3	100	1321-3R130-B	75 (100)	100-D110D11
	270	270	220.6	200	1321-3RB250-B	149 (200)	100-D250ED11
	405	405	330.9	300	1321-3RB320-B	224 (300)	100-D420ED11
C	540	540	441.2	400	1321-3RB500-B	298 (400)	100-D630ED11
	675	675	551.5	500	1321-3R600-B	373 (500)	100-D630ED11
D	810	810	661.8	600	1321-3R750-B	447 (600)	100-D860ED11
	1K0	1080	882.4	800	1321-3R1000-B	597 (800)	100-G700KD22
	1K2	1215	992.7	900	1321-3R1000-B	671 (900)	100-G860KD22
	1K3	1350	1103.0	1000	2 x 1321-3R600-B	746 (1000)	100-G1000KD12
	1K6	1687.5	1378.7	1250	2 x 1321-3R750-B	—	(1)

(1) No AC input contactor available for this drive rating – must be sourced locally.

PowerFlex DC Drives – 690V AC Input Drives

Frame	Drive Current Rating Code	DC amps	AC Line amps	Hp	IP00 (Open Style) Line Reactor Cat No.	Line Reactor kW (Hp)	AC Input Contactor Cat. No.
C	452	452	369	400	1321-3RB500-C	—	100-D420ED11
	565	565	462	500	1321-3RB600-C		100-D630ED11
D	678	678	554	600	1321-3R750-C		100-D630ED11
	791	791	646	700	1321-3R750-C		100-D860ED11
	904	904	739	800	1321-3R1000-C		100-D860ED11
	1K0	1017	831	900	1321-3R1000-C		100-D860ED11
	1K1	1130	923	1000	2 x 1321-3R600-C		100-G700KD22
	1K2	1243	1016	1100	2 x 1321-3R600-C		100-G860KD22
	1K4	1412.5	1154	1250	2 x 1321-3R750-C		100-G1200KD12
	1K5	1582	1292	1400	2 x 1321-3R750-C		100-G1200KD12

PowerFlex DC Field Controller AC Input Line Reactors and AC Contactors

These tables contain the recommended AC input line reactors and AC contactors for use with the PowerFlex DC field controller.

IMPORTANT An AC input contactor can only be used when the device is used in 'standalone' mode. An AC contactor for a device cannot be used when a PowerFlex DC field controller is paired with and controlled by a PowerFlex DC drive.



ATTENTION: Do not remove AC power until the field controller output (load) current is zero. Equipment damage can occur.

PowerFlex DC Field Controller – 200V AC Input

Frame	Field Controller Cat. No.	DC amps	AC Line amps	IP00 (Open Style) Line Reactor Cat No.	Line Reactor kW	AC Input Contactor Cat. No.
A	23PFCB017	17	14.45	1321-3R18-A	0.75...3.7	100-C23D10
	23PFCB060	60	51	1321-3R80-A	15	100-C60D10
	23PFCB120	120	102	1321-3R160-A	30...37	100-D140D11
B	23PFCB245	245	208	1321-3RB250-A	45...56	100-D250ED11
	23PFCB365	365	310	1321-3RB400-A	93	100-D420ED11
	23PFCB570	570	485	1321-3R600-A	149	100-D630ED11

PowerFlex DC Field Controller – 500V AC Input

Frame	Field Controller Cat. No.	DC amps	AC Line amps	IP00 (Open Style) Line Reactor Cat No.	Line Reactor kW	AC Input Contactor Cat. No.
A	23PFCD017	17	14.45	1321-3R18-B	1.5...7.5	100-C23D10
	23PFCD060	60	51	1321-3R80-B	30	100-C60D10
	23PFCD120	120	102	1321-3R160-B	56...75	100-D110D11
B	23PFCD245	245	208	1321-3RB250-B	93...112	100-D210ED11
	23PFCD365	365	310	1321-3RB400-B	186.4	100-D420ED11
	23PFCD570	570	485	1321-3R600-B	298.3	100-D630ED11

Install an SCR Overvoltage Protection Device

When the PowerFlex DC field controller is used as a motor/generator field supply, an overvoltage protection device (voltage clamp) must be installed on the field controller load. The purpose of the voltage clamp is to provide a means to let the DC output current to the load decay if the power is interrupted to the field controller. If the AC power to the connected field controller is interrupted, the current in the DC output to the field starts to decay rapidly. This rapid decay generates voltages that are in direct proportion to the rate of decay of the 'field collapse.' These voltages can damage the field controller and/or the motor wire insulation. The voltage clamp is connected directly across the DC output power connections to the load and during normal operation it appears as an open circuit. See [PowerFlex Field Controller with AC Input Contactor on page 28](#), for an illustration of the voltage clamp installation location.

Dynamic Brake Resistor Kits and DC Output Contactors

See [Alternate Dynamic Brake Resistor Kits and DC Output Contactors on page 18](#) for recommended alternate DC Output Contactors for 575V and 690V AC input drives, respectively.

230V AC Input Drives

Frame	Drive Current Rating Code	DC Amps	AC Line Amps	Hp	Dynamic Brake Resistor Kit Cat. No.	Armature Voltage (Volts)	Total dB Resistance (ohms)	DC Loop Contactor Cat. No. ⁽²⁾		DC Contactor Crimp Lugs Cat. No. ⁽³⁾		
								Drive without Dynamic Brake	Drive with Dynamic Brake			
A	7P0	7	5.7	1.5	1370-DBL62	240	20	1370-NC56	1370-DC56	1370-LG40		
	9P0	9	7.4	2	1370-DBL63							
	012	12	9.8	3	1370-DBL64							
	020	20	16	5	1370-DBL65							
	029	29	24	7.5	1370-DBL66							
	038	38	31	10	1370-DBL67							
	055	55	45	15	1370-DBL68							
	073	73	60	20	1370-DBL69					1370-LG56		
	093	93	76	25	1370-DBL70							
	110	110	90	30	1370-DBL71							
B	146	146	119	40	1370-DBL72	240	1.4	1370-NC180	1370-DC180	1370-LG92		
	180	180	147	50	1370-DBL73					1370-LG160		
	218	218	178	60	1370-DBL74			1370-LG180				
	265	265	217	75	1370-DBL75			1370-LG228				
	360	360	294	100	1370-DBL76			1370-LG268				
	434	434	355	125	CUTLER-HAMMER_G3AP50 (Qty 4 - two in series, two in parallel)			0.4	ABB_EHDB520C2P-1L2S	ABB_EHDB520C-1L22SS	(4)	
	C	521	521	426	150			HUBBELL_Y139W322GB	0.322	ABB_EHDB800C2P-1L2S		ABB_EHDB800C-1L22SS
		700	700	572	200			(1)	0.25	ABB_EHDB960C2P-1L2S		ABB_EHDB960C-1L22SS
D	875	875	715	250	0.2	ABB_EHDB960C2P-1L2S	ABB_EHDB960C-1L22SS					
	1K0	1050	858	300	0.2	SIEMENS-MFG_14-193-101-58-2 (Qty 2)	SIEMENS-MFG_14-193-101-58-2 (Qty 1)					

(1) No dynamic brake resistor kit available for this drive rating—must be sourced locally.
 (2) Coil voltage = 115V AC, 50/60Hz.
 (3) For more information, see [DC Contactor Crimp Lug Kit Specifications on page 17](#).
 (4) Wire and lug size dependent on enclosure dimensions and local codes.

460V AC Input Drives

Frame	Drive Current Rating Code	DC Amps	AC Line Amps	Hp	Dynamic Brake Resistor Kit Cat. No.	Armature Voltage (Volts)	Total dB Resistance (ohms)	DC Loop Contactor Cat. No. ⁽²⁾		DC Contactor Crimp Lugs Cat. No. ⁽³⁾				
								Drive without Dynamic Brake	Drive with Dynamic Brake					
A	4P1	4.1	3.3	2	1370-DBH63	500	81	1370-NC56	1370-DC56	1370-LG40				
	6P0	6	4.9	3	1370-DBH64		62							
	010	10	8.2	5	1370-DBH65		45							
	014	14	11.4	7.5	1370-DBH66		27							
	019	19	15.5	10	1370-DBH67		20							
	027	27	22.1	15	1370-DBH68		12							
	035	35	28.6	20	1370-DBH69		10				1370-DC56	1370-LG40		
	045	45	36.8	25	1370-DBH70		9					1370-LG52		
	052	52	42.5	30	1370-DBH71		7							
	B	073	73	59.6	40		1370-DBH72				5.2	1370-NC110	1370-DC110	1370-LG92
		086	86	70.3	50		1370-DBH73				4			
		100	100	81.7	60		1370-DBH74				4	1370-NC180	1370-DC180	1370-LG110
129		129	105.4	75	1370-DBH75	3	1370-LG140							
167		167	136.4	100	1370-DBH76	2.1	1370-LG180							
207		207	169.1	125	1370-DBH77	1.5	1370-NC280	1370-DC280	1370-LG228					
250		250	204.3	150	1370-DBH78	1.05			1370-LG268					
330		330	269.6	200	1370-DBH79	1	ABB_EHDB360C2P-1L2S	ABB_EHDB360C-1L22SS	(4)					
C		412	412	336.6	250	HUBBELL_Y95W808GB	0.8	ABB_EHDB520C2P-1L2S		ABB_EHDB520C-1L22SS				
		495	495	404.4	300	HUBBELL_Y101W595GB	0.625	ABB_EHDB800C2P-1L2S		ABB_EHDB800C-1L22SS				
	667	667	544.9	400	HUBBELL_Y109W542GB	0.463	ABB_EHDB960C2P-1L2S	ABB_EHDB960C-1L22SS						
D	800	830	678.1	500	(1)	0.322	SIEMENS-MFG_14-193-101-58-2 (Qty 2)	SIEMENS-MFG_14-193-101-58-2 (Qty 1)						
	960	996	813.7	600		0.255	CUTLER-HAMMER_6702ED636-2 (Qty 2)	CUTLER-HAMMER_6702ED636-2 (Qty 1)						
	1K1	1162	949.4	700										
	1K3	1328	1085.0	800										
	1K4	1494	1220.6	900										

(1) No dynamic brake resistor kit available for this drive rating—must be sourced locally.

(2) Coil voltage = 115V AC, 50/60Hz.

(3) For more information, see [DC Contactor Crimp Lug Kit Specifications on page 17](#).

(4) Wire and lug size dependent on enclosure dimensions and local codes.

DC Contactor Crimp Lug Kit Specifications

Use the information that is provided in this table to help you order the correct Lug kit for your application.

Rated Motor Armature Current ⁽¹⁾ A DC	DC Contactor Rating A DC	Armature Conductor Size ⁽²⁾ AWG	dB Conductor Size ⁽³⁾ AWG	Armature Conductor Crimp Lug Hole Size	dB Conductor Crimp Lug Hole Size	Lug Kit Catalog Number
4.1...35	56	8	8	#10	#10	1370-LG40
45...52		6				1370-LG52
55		4				1370-LG56
60...86	110	2	6	0.25 in.	0.25 in.	1370-LG92
100...110		1/0				4
129	180	2/0	2	0.3125 in.	0.3125 in.	1370-LG140
146		3/0				1370-LG160
147...167		4/0				1370-LG180
207...218	280	300MCM	1/0	0.5 in.	0.375 in.	1370-LG228
250...265		400MCM	2/0			1370-LG268
266...280		500MCM	3/0			1370-LG280

(1) The Rated Motor Armature Current is taken directly from the motor nameplate or motor data. The current listed in this column is the maximum current that is allowed for the Armature Conductor Size (column 3) and the DC Contactor Rating (column 2).

(2) The armature conductors are sized by multiplying the Rated Motor Armature Current by 1.25 as provided for in NEC 420-22 (1987). The DC lug ratings are determined from NEC Table 310-16 (1987) for copper conductors, insulation temperature that is rated at 75° C (167° F) at an ambient temperature of 30° C (86° F). If conditions are other than shown in NEC Table 310-16, then refer to application codes.

(3) The dynamic braking (dB) conductors are sized as in footnote 2, but at half ampacity due to the short time duration of current flow in these conductors, and has been sized to satisfy NEMA Standard ICS 3-302.62 - Dynamic Braking. If the load inertia is larger than the motor inertia, calculations must be made to determine correct conductor sizing and dB resistor wattage per NEMA Standard ICS 3-302.62.

Alternate Dynamic Brake Resistor Kits and DC Output Contactors

The following alternate dynamic brake resistor kits and/or DC output contactors can be used with the corresponding PowerFlex DC drives but must be sourced separately from the drive.

575V AC Input Drives

Frame	Drive Current Rating Code	DC Amps	AC Line Amps	Hp	Armature Voltage (Volts)	dB Resistor Size (ohms)	DC Loop Contactor Cat. No. ⁽¹⁾		DC Contactor Crimp Lugs Cat. No. ⁽²⁾
							Drive w/No Dynamic Brake	Drive w Dynamic Brake	
B	067	67.5	55.1	50	600	5.93	ABB_EHDB220C2P-1L2S	ABB_EHDB220C-1L22SS	(3)
	101	101	83	75		3.95			
	135	135	110	100		2.96			
	270	270	221	200		1.48	ABB_EHDB360C2P-1L2S	ABB_EHDB360C-1L22SS	
	405	405	331	300		0.988	ABB_EHDB520C2P-1L2S	ABB_EHDB520C-1L22SS	
C	540	540	441	400		0.741	ABB_EHDB650C2P-1L2S	ABB_EHDB650C-1L22SS	
	675	675	551	500		0.593	ABB_EHDB800C2P-1L2S	ABB_EHDB800C-1L22SS	
D	810	810	662	600		0.494	ABB_EHDB960C2P-1L2S	ABB_EHDB960C-1L22SS	
	1K0	1080	882	800		0.370	SIEMENS-MFG_14-193-101-58-2 (Qty 2)	SIEMENS-MFG_14-193-101-58-2 (Qty 1)	
	1K2	1215	993	900		0.329			
	1K3	1350	1103	1000	0.296	CUTLER-HAMMER_6702ED636-2 (Qty 2)	CUTLER-HAMMER_6702ED636-2 (Qty 1)		
	1K6	1688	1379	1250	0.237				

- (1) Coil voltage = 115V AC, 50/60Hz.
- (2) For more information, see [DC Contactor Crimp Lug Kit Specifications on page 17](#).
- (3) Wire and lug size dependent on enclosure dimensions and local codes.

690V AC Input Drives

Frame	Drive Current Rating Code	DC Amps	AC Line Amps	Hp	Armature Voltage (Volts)	dB Resistor Size (ohms)	DC Loop Contactor Cat. No. ⁽¹⁾		DC Contactor Crimp Lugs Cat. No. ⁽²⁾
							Drive w/No Dynamic Brake	Drive w Dynamic Brake	
C	452	452	369	400	700	1.03	SIEMENS-MFG_14-193-101-58-2 (Qty 2)	SIEMENS-MFG_14-193-101-58-2 (Qty 1)	(3)
	565	565	462	500		0.826			
D	678	678	554	600		0.688			
	791	791	646	700		0.590			
	904	904	739	800		0.516			
	1K0	1017	831	900		0.459			
	1K1	1130	923	1000		0.413			
	1K2	1243	1016	1100		0.375			
	1K4	1413	1154	1250		0.330	CUTLER-HAMMER_6702ED636-2 (Qty 2)	CUTLER-HAMMER_6702ED636-2 (Qty 1)	
	1K5	1582	1292	1400		0.295			

- (1) Coil voltage = 115V AC, 50/60Hz.
- (2) For more information, see [DC Contactor Crimp Lug Kit Specifications on page 17](#).
- (3) Wire and lug size dependent on enclosure dimensions and local codes.

Frame D Terminal Adapter Kits

The following frame D drives require the listed terminal adapter kits to meet UL installation requirements.

Voltage Class	Drive Current Rating Code	U, V, W Terminal Adapter Kit No.	C, D Terminal Adapter Kit No.
230	1K0	SK-20P-S726172	—
460	1K1	SK-20P-S726171	
	1K3		
	1K4		
575	1K0	SK-20P-S726172	
	1K2	SK-20P-S726171	
	1K3		
	1K6		
690	1K0	SK-20P-S726172	
	1K1	SK-20P-S726171	
	1K2		
	1K4		
	1K5		

Installation Considerations

PowerFlex DC Drive

The PowerFlex DC drive has the following built in protective features to help simplify installation:

- Ground fault protection during startup and operation to help provide excellent reliability
- Electronic motor overload protection increases motor life

There are many other factors that must be considered for optimal performance in any given application. This block diagram highlights the primary installation considerations.

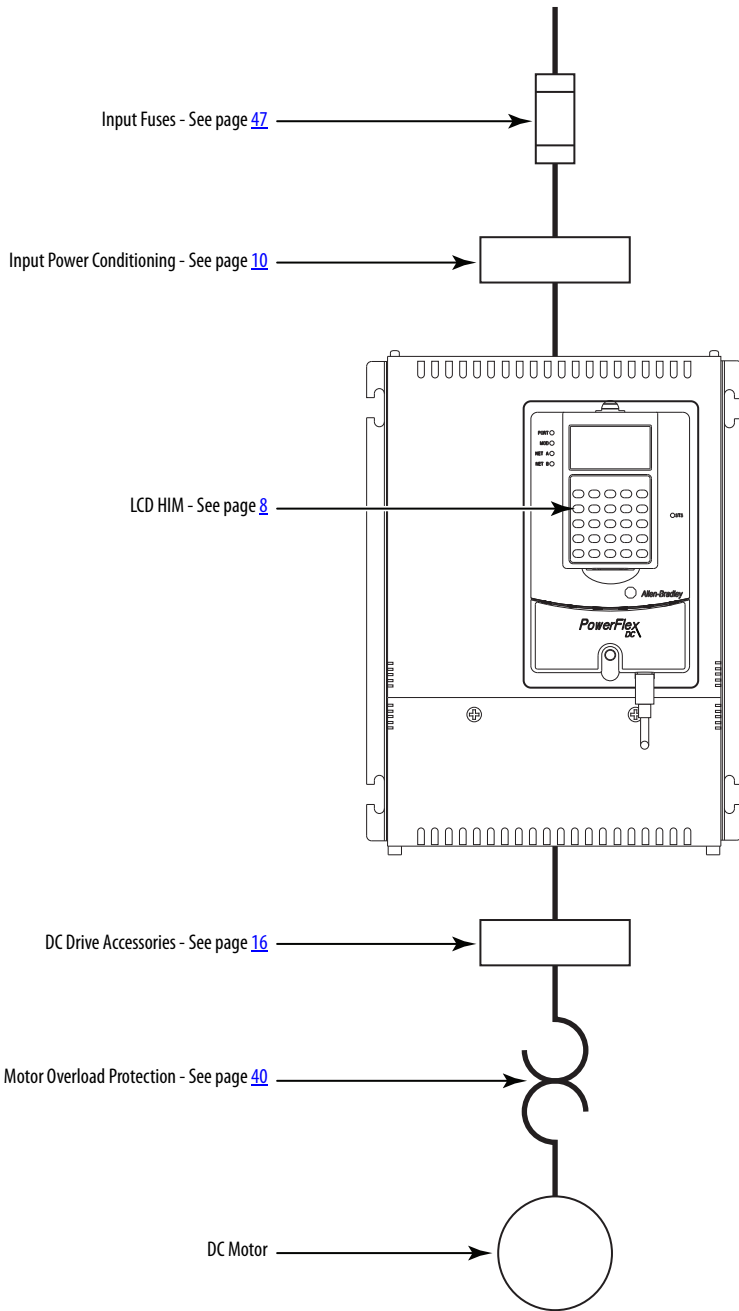

PowerFlex DC Field Controller

Consider the installation considerations that are shown in this block diagram for optimal performance in any given application.

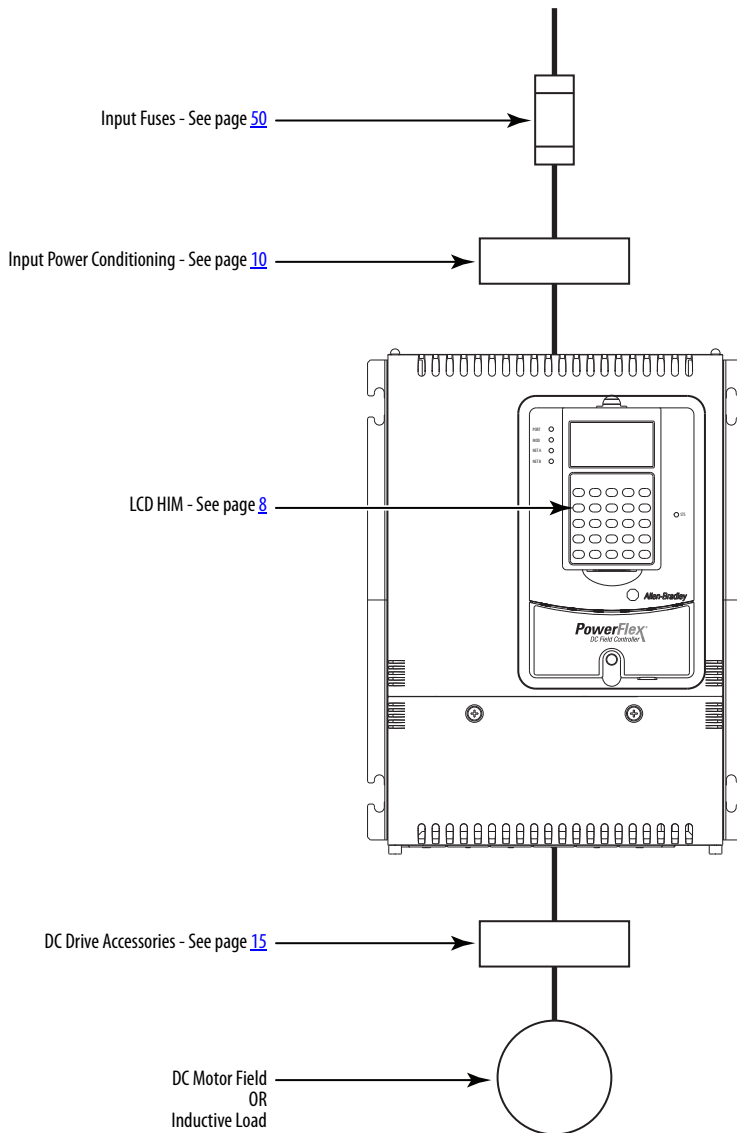

PowerFlex DC Drives Power Wiring

AC Input Voltages

PowerFlex DC drives are rated for the following AC input voltages @ 50/60 Hz $\pm 5\%$:

Mains Circuit (Terminals U, V, W)

- 230V $\pm 10\%$, 3Ph
- 400V $\pm 10\%$, 3Ph
- 440V $\pm 10\%$, 3Ph
- 460V $\pm 10\%$, 3Ph
- 480V $\pm 10\%$, 3Ph
- 575V $\pm 10\%$, 3Ph
- 690V $\pm 10\%$, 3Ph

Field Circuit (Terminals U1, V1)

- 230V \pm 10%, 1Ph
- 400V \pm 10%, 1Ph
- 460V \pm 10%, 1Ph

Control Circuit (Terminals U2, V2)

- 115V \pm 15% or 230V \pm 15%, 1Ph

IMPORTANT

For only frame B and C drives, a jumper must be placed between terminals SA-SB when 115V AC input power is used for the control circuit. See Frame B Drives SA-SB Terminal Block Location on page 36 and Frame C Drives SA-SB Terminal Block Location on page 36 for terminal block locations.

DC Output Voltages

The output voltages that are listed in these two tables take into account an AC input undervoltage within the stated tolerance limits and a voltage drop of 4% due to an AC input line reactor. It is the same as the rated armature voltage suggested for the connected motor.

Armature Circuit

AC Input Voltage (Terminals U, V, W)	DC Output Armature Voltage (Terminals C & D)	
	Two Quadrant Drive	Four Quadrant Drive
230V \pm 10%, 3Ph	260V	240V
400V \pm 10%, 3Ph	470V	420V
440V \pm 10%, 3Ph	530V	460V
460V \pm 10%, 3Ph	560V	480V
480V \pm 10%, 3Ph	580V	500V
575V \pm 10%, 3Ph	680V	600V
690V \pm 10%, 3Ph	810V	720V

Field Circuit

AC Input Voltage (Terminals U1 & V1)	DC Output Field Voltage ⁽¹⁾ (Terminals C1 & D1)	
	Fixed Field	Adjustable Field
230V \pm 10%, 1Ph	200V	200V
400V \pm 10%, 1Ph	310V	310V
460V \pm 10%, 1Ph	360V	360V

(1) The maximum field voltage is equal to 0.85 x AC input line voltage

PowerFlex Field Controllers Power Wiring*AC Input Voltages*

PowerFlex field controllers are rated for the following AC input voltages @ 50/60 Hz \pm 5%:

Mains Circuit (Terminals U, V, W)

- Cat. No. 23PFBCxxx: 60...200V AC, \pm 10%, 3Ph
- Cat. No. 23PFCDxxx: 230...500V AC, \pm 10%, 3Ph

Control Circuit (Terminals U2, V2)

- 115V \pm 15% or 230V \pm 15%, 1Ph

IMPORTANT

For only frame B field controllers, a jumper must be placed between terminals SA-SB on the switching power supply circuit board for the control circuits to work with 115V AC input. See Frame B Drives SA-SB Terminal Block Location on page 25 for terminal block locations.

DC Output Voltages

The output voltages that are shown here include an AC input undervoltage within the stated tolerance limits and a voltage drop of 4% due to an AC input line reactor. It is the same as the rated armature voltage suggested for the connected load.

AC Input Voltage (Terminals U, V, W)	DC Output Voltage (Terminals C and D)
200V, $\pm 10\%$, 3Ph	210V
230V, $\pm 10\%$, 3Ph	240V
400V, $\pm 10\%$, 3Ph	420V ⁽¹⁾
440V, $\pm 10\%$, 3Ph	460V
460V, $\pm 10\%$, 3Ph	480V
480V $\pm 10\%$, 3Ph	500V
500V, $\pm 10\%$, 3Ph	520V ⁽¹⁾

(1) Voltage measured according to DIN 40 030 (09/93)

Typical Power Wiring Diagrams

The following diagrams represent recommended power wiring configurations for standard PowerFlex DC drive installations.

PowerFlex DC Drive Power Wiring with DC Output Contactor

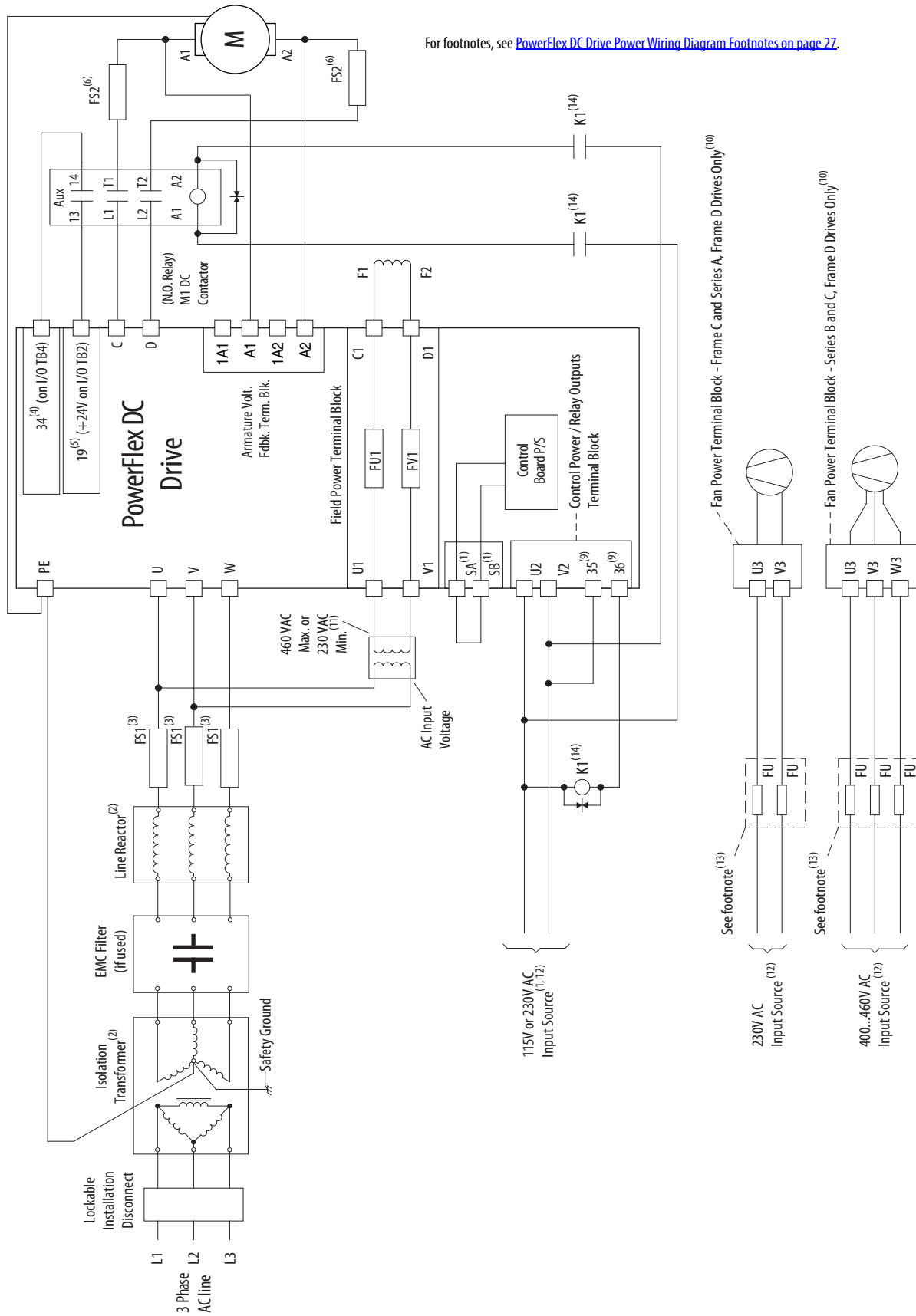

PowerFlex DC Drive Power Wiring with DC Output/Dynamic Braking Contactor and a Dynamic Brake

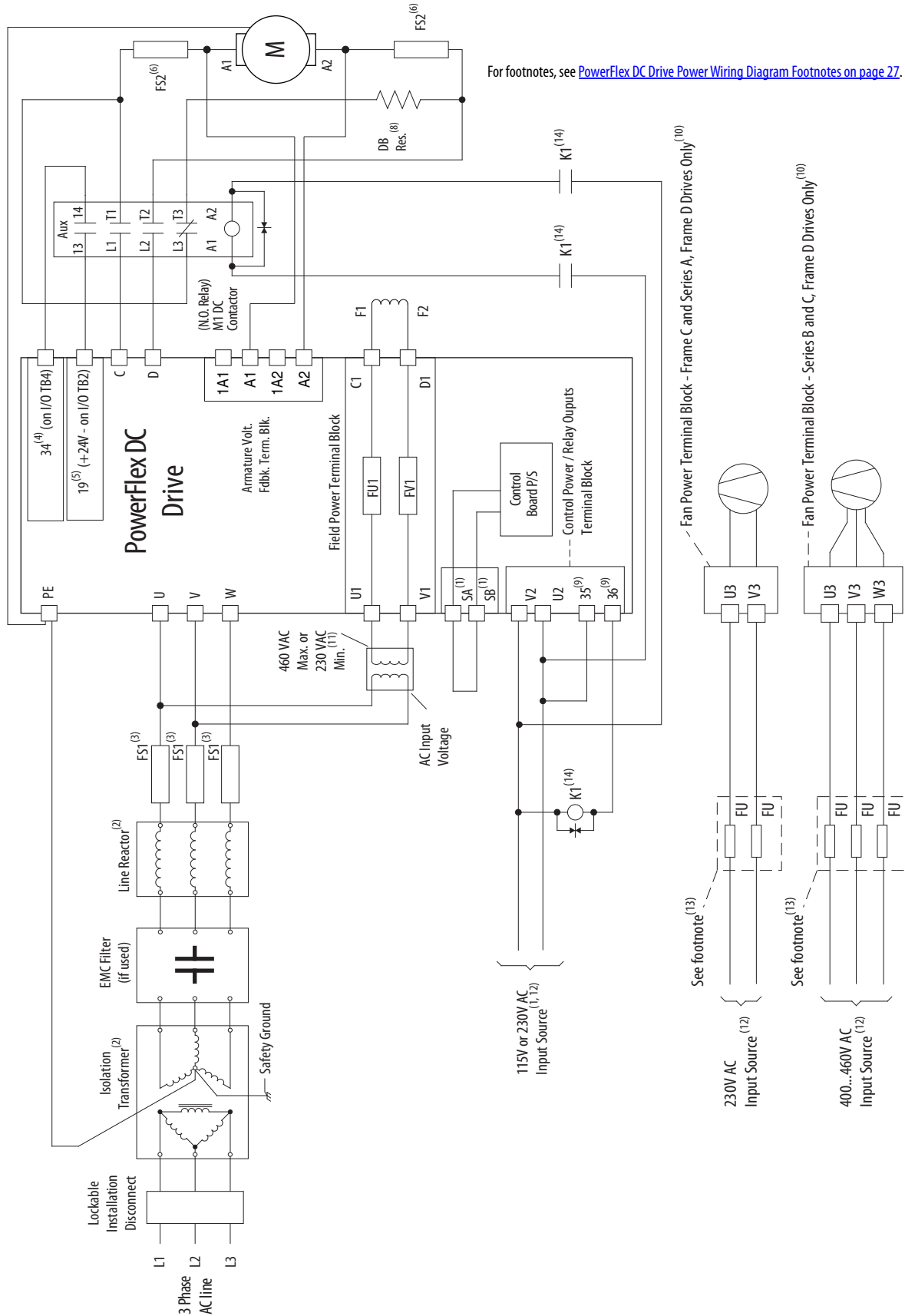

PowerFlex DC Drive Power Wiring Diagram Footnotes

1. For frame B and C drives only, a jumper is required between terminals SA and SB for 115V AC control input power. See [PowerFlex DC Drives and Field Controller Control Circuit Input Power on page 34](#) for more information.
2. An isolation transformer and/or 3...5% impedance line reactor is required. If the isolation transformer provides the required 3...5% impedance, a line reactor is not required. For recommendations, see [Isolation Transformers on page 10](#) and [AC Input Line Reactors and Contactors on page 12](#). We recommend that the isolation transformer has a grounded wye secondary neutral. If the PowerFlex DC drive is installed in a system with an ungrounded wye neutral, or with an impedance ground connection, see Grounding for Installations in an Ungrounded or High-Impedance Neutral Ground or System in the PowerFlex Digital DC Drive User Manual, publication [20P-UM001](#), for more information.
3. AC input fuses for the armature converter are not provided for frame A and B drives (the customer must purchase). AC input fuses for the armature converter are internally mounted on frame C and D drives. For fuse recommendations, see [PowerFlex DC Drives and Field Controller Circuit Protection on page 47](#).
4. Par 140 [Digital In8 Sel] set to 31 'Contactor'
5. If the +24V internal power supply is used, terminal 18 (24V common) must be jumpered to terminal 35 (digital input common).
6. For four quadrant frame A and B drives, armature output fuses are required (the customer must purchase). For two quadrant frame A and B drives, armature output fuses are recommended (the customer must purchase). For fuse recommendations, see [PowerFlex DC Drives and Field Controller Circuit Protection on page 47](#).
7. When you use an AC input contactor, armature voltage feedback is not required.
8. The 'Enable' input must be removed to perform a dynamic braking stop.
9. Par 1391 [ContactorControl] = 1 'AC Cntctr' and Par 1392 [Relay Out 1 Sel] = 25 'Contactor.' Important: Terminals 35 and 36 are on the Control Power / Relay Outputs Terminal block, NOT the I/O terminal blocks. See [Frames A and B Contact Relay and Thermistor Terminal Block Locations on page 40](#), and [Frame D Contact Relay and Thermistor Terminal Block Locations \(only for PowerFlex DC Drives\) on page 41](#).
10. Frame C and D drives require only an external power supply for the heat sink cooling fans. For more information, see [Frame C Heat Sink Cooling Fan Specifications on page 37](#) and [Frame D, Series B and C Heat Sink Cooling Fan Specifications on page 38](#).
11. See [PowerFlex DC Drive Field Converter Connections on page 33](#).
12. If sourced from the main three-phase AC input, the connections must be taken from the primary side of the Isolation Transformer or Line Reactor (clean power).
13. Fuses or a circuit breaker. For more information, see [Frame C Heat Sink Cooling Fan Specifications on page 37](#) and [Frame D, Series B and C Heat Sink Cooling Fan Specifications on page 38](#).
14. For frames B, C, and D drives, a pilot relay is required for the contactor coil.

Armature Power Terminal Connections

Terminals	Description
U, V, W	Three-phase AC input to the armature converter
C, D	DC output to the motor armature
PE	Safety ground

PowerFlex Field Controller with AC Input Contactor

This illustration represents the recommended power wiring configuration for a standard PowerFlex DC field controller installation with an AC contactor.

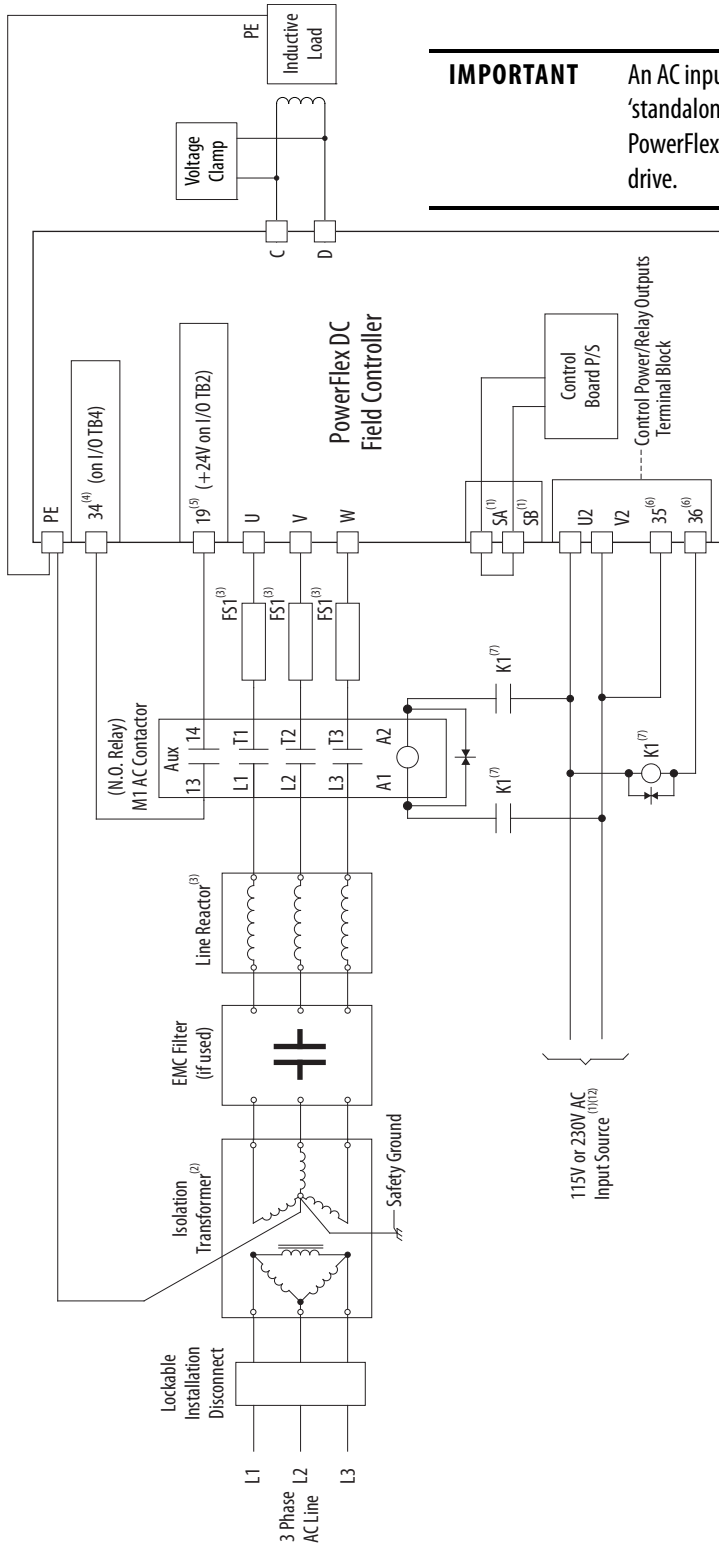

IMPORTANT An AC input contactor can only be used when the device is used in 'standalone' mode. An AC contactor for a device cannot be used when a PowerFlex DC field controller is paired with and controlled by a PowerFlex DC drive.

PowerFlex Field Controller Power Wiring Diagram Notes

1. For frame B field controllers only, a jumper is required between terminals SA and SB for 115V AC control input power. For more information, see [PowerFlex Field Controllers Power Wiring on page 22](#).
2. An isolation transformer and/or 3...5% impedance line reactor is required. If the isolation transformer provides the required 3...5% impedance, a line reactor is not required. For recommendations, see [PowerFlex DC Field Controller AC Input Line Reactors and AC Contactors on page 15](#). It is recommended that the isolation transformer has a grounded wye secondary neutral. If the PowerFlex DC field controller is installed in a system with an ungrounded wye neutral or with an impedance ground connection, see Grounding for Installations in an Ungrounded or High-impedance, Neutral Ground, or System in the PowerFlex DC Field Controller Installation Instructions, publication [23PFC-IN001](#).
3. AC input fuses (FS1) for the field converter are not provided with field controllers. For fuse recommendations, see [Field Controller Frames A and B AC Input Line Fuses on page 50](#).
4. Par 140 [Digital In8 Sel] set to 31 "Contactor."
5. If the +24V internal power supply is used, terminal 18 (24V common) must be jumpered to terminal 35 (digital input common).
6. Par 1391 [ContactorControl] = 1 "AC Cntctr" and Par 1392 [Relay Out 1 Sel] = 25 "Contactor". Important: Terminals 35 and 36 are on the Control Power/Relay Outputs Terminal block, NOT the I/O terminal blocks. See [Frames A and B Contact Relay and Thermistor Terminal Block Locations on page 40](#).
7. For frames B field controllers only, a pilot relay is required for the contactor coil.

PowerFlex DC Drives Terminal Block Locations

Frame A Armature Terminal Block Locations

Bottom View

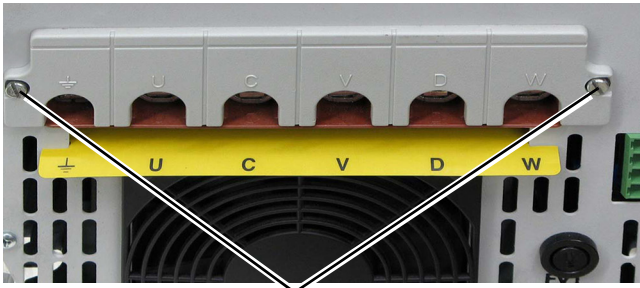

Loosen the two screws that secure the power terminal cover to the drive chassis.
Remove the power terminal cover to connect the armature power wiring.

Front View

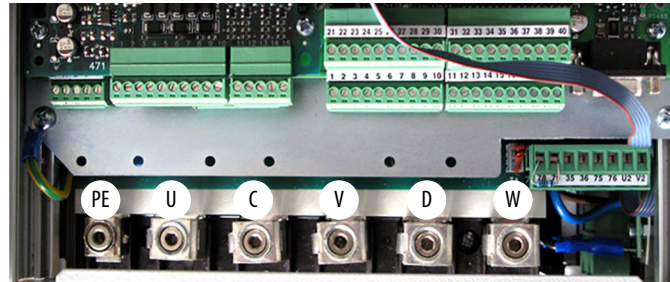

Front view of drive is shown with bottom protective and power terminal covers removed.



ATTENTION: Do not operate the drive with the power terminal cover removed. Operating the drive with the power terminal cover removed can result in a hazardous condition that can cause personal injury and/or equipment damage.

Frame B Armature Terminal Block Locations

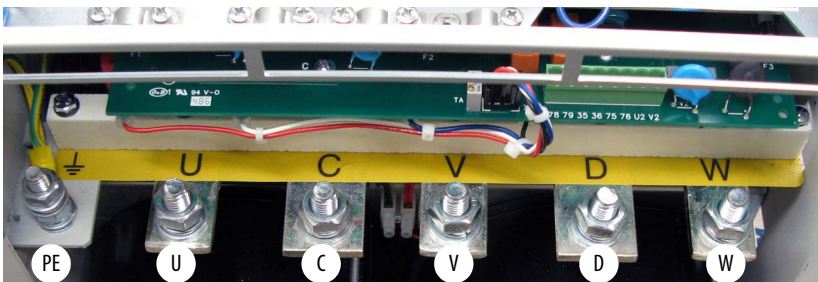

Frame C Armature Terminal Block Locations

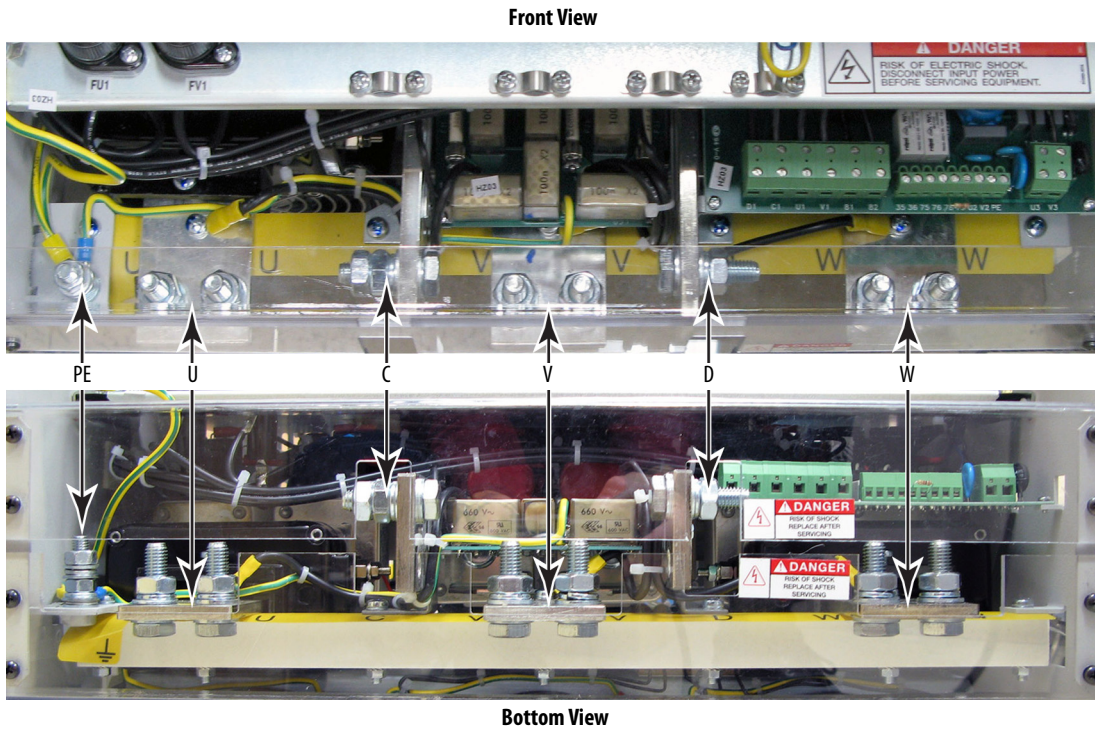

Frame D Armature Terminal Block Locations

IMPORTANT Certain frame D drives require the use of a terminal adapter kits for terminals U, V, W, C and D. See Frame D Terminal Adapter Kits on page 19 for details.

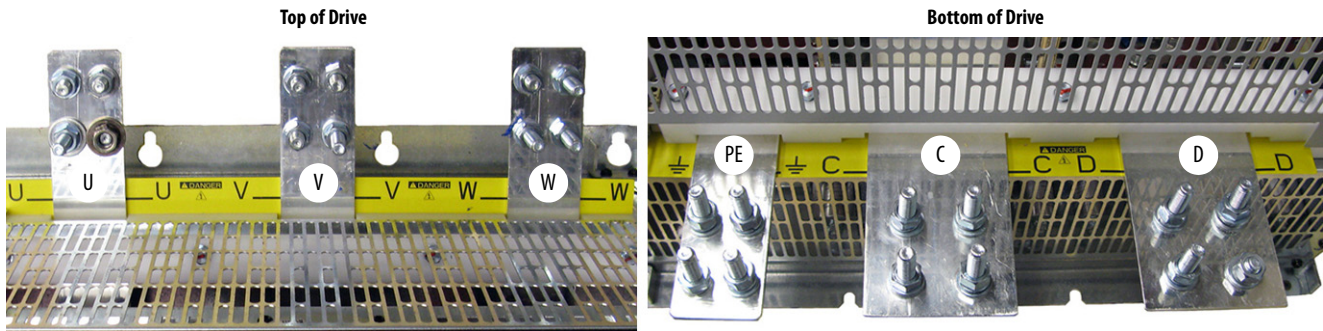

Armature Power Terminal and Ground (PE) Wire Sizes

Frame	Drive Current Rating Code ⁽¹⁾				Terminals	Wire Size and Type	Terminal Bolt Size (mm)	Final Torque N·m (lb·in)
	230V	460V	575V	690V				
A	7P0...055	4P1...052	—	—	U, V, W, C, D, PE	See Cable and Wiring Recommendations in the PowerFlex Digital DC Drive User Manual, publication 20P-UM001 .	5	6 (53)
	073...110	073...129					Terminal Block	12 (106)
B	All	All	—	—	U, V, W, C, D		10	25 (221)
PE					8		15 (132.75)	
C	All	All	—	—	U, V, W, C, D		10	25 (221)
PE					8		15 (132.75)	
D	All	All	All	All	U, V, W, C, D, PE		12	45 (398.2)

(1) See [PowerFlex DC Drive Catalog Number Explanation on page 6](#), positions 8, 9 and 10 for corresponding drive Hp rating, armature Amp rating, and field Amp rating.

IMPORTANT Certain frame D drives require the use of a terminal adapter kit for terminals U, V, W, C, and D. For details, see [Frame D Terminal Adapter Kits on page 19](#).

PowerFlex DC Drive Armature Voltage Feedback Connections

The armature voltage feedback terminals can be used to monitor the armature voltage of the motor, regardless of the state of a DC contactor or inverting fault device (fuse or breaker).

If these terminals are not connected to the motor armature, jumpers must be installed between A1 to 1A1 and A2 to 1A2 to allow internal calculation of motor speed from armature voltage (needed when no speed feedback device is used). If a DC contactor is used without a speed feedback device present, the drive cannot determine motor speed from the armature voltage feedback signal.

IMPORTANT By default, these terminals are jumpered - 1A1 to A1 and 1A2 to A2. If these terminals are not wired to the motor terminals, the jumpers must be installed.

This terminal block is not present on drives that were shipped from the factory before drives with version 3.001 firmware installed. However, new pulse transformer boards that are shipped as replacement parts from the factory contain this terminal block and can be used with any version of firmware.

Armature Voltage Feedback Terminals

Terminal	Description
1A1	Jumpered to A1 when internal armature voltage feedback is used. Not used when A1 is connected to motor terminal A1.
A1	Voltage feedback from motor terminal A1.
1A2	Jumpered to A2 when internal armature voltage feedback is used. Not used when A2 is connected to motor terminal A2.
A2	Voltage feedback from motor terminal A2.

Armature Voltage Feedback Circuit Wire Sizes and Terminal Specifications

Frame	Terminals	Wire Size and Type ⁽¹⁾	Tightening Torque N·m (lb·in)
A, B & C	1A1, A1, 1A2, A2	24...10 AWG/kcmils	0.5...0.6 (4.4...5.3)
D		22...8 AWG/kcmils	0.8...1.6 (7.1...14.2)

(1) Wire with an insulation rating of 600V or greater is recommended. For more information, see Cable and Wiring Recommendations in the PowerFlex Digital DC Drive User Manual, publication [20P-UM001](#).

Frame A Armature Voltage Feedback Circuit Terminal Block Location

Bottom of View of Drives

Drive with no fan

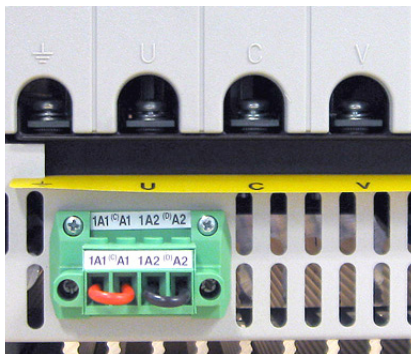

Drive with fan

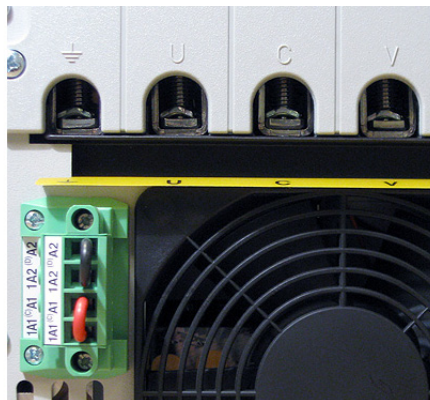

Shown with terminals jumpered for internal armature voltage feedback.

Frame B Armature Voltage Feedback Circuit Terminal Block Location

Top of Drive

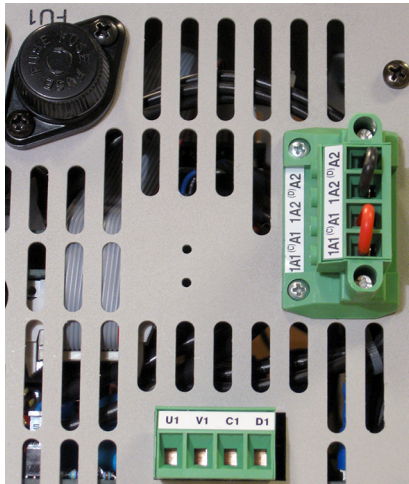

Shown with terminals jumpered for internal armature voltage feedback.

Frame C Armature Voltage Feedback Circuit Terminal Block Location

Bottom of Drive

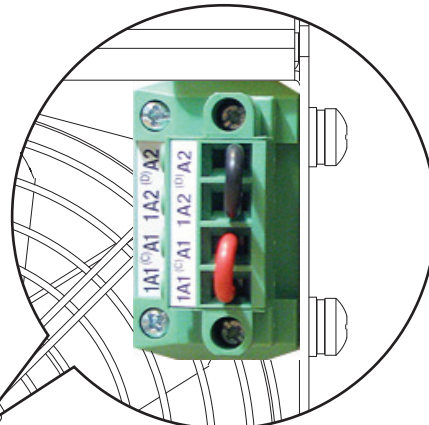
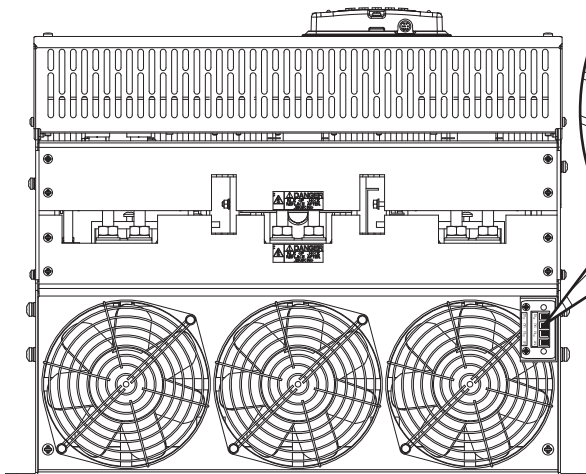

Shown with terminals jumpered for internal armature voltage feedback.

Frame D Armature Voltage Feedback Circuit Terminal Block Location

Bottom of Drive, Left Side

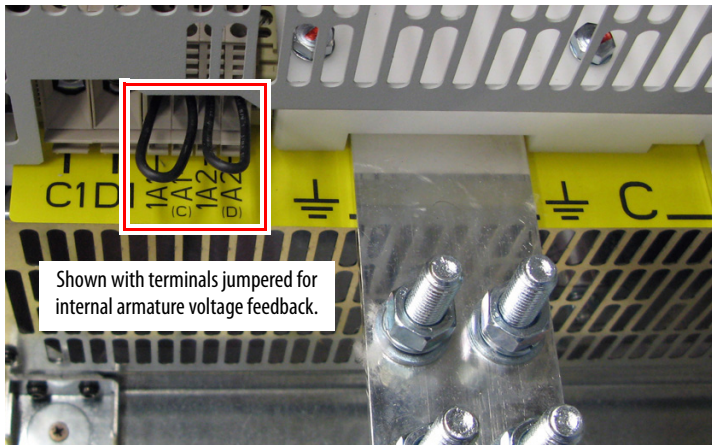

Shown with terminals jumpered for internal armature voltage feedback.

PowerFlex DC Drive Field Converter Connections

For only 575V or 690V AC input drives, a step-down transformer with the following specifications must be installed before the input to the field control circuit (terminals U1, V1):

- For a 150V motor field, use a step-down transformer with a 230VAC secondary
- For a 300V motor field, use a step-down transformer with a 460VAC secondary

Also, If the rated voltage of the DC motor field is not compatible with the field DC output voltage of the drive, an external field control transformer must be used. See the following example for transformer selection information.

Example: 10 Hp, 240V Armature, 17.2 A, 240V Field, 2.0 A motor

- The field control transformer must have a 230V primary, a 460V secondary, and be single-phase, 60 Hz
- $kVA = 2 A \times 460VAC \times 1.5 = 1.38 kVA$ (1.5 kVA is closest)

In addition, the following configuration must be completed in the PowerFlex DC drive:

- Control board DIP switch S14 must be set to select a value of 2 A.
- Parameter 374 [Drv Fld Brdg Cur] must be programmed to match DIP switch S14 = "2."
- Parameter 280 [Nom Mtr Fld amps] must be programmed to the rated motor nameplate field current "2."

Drive Field Converter Terminal Designations

Terminal	Description
U1, V1	Single-phase AC line input power to the field circuit.
C1, D1	DC output power to the motor field.

Frames A and B Field Circuit Terminal Block Locations

Bottom View of Frame A

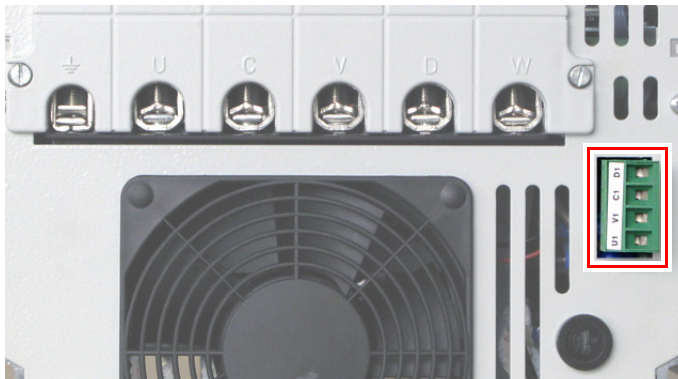

Top View of Frame B

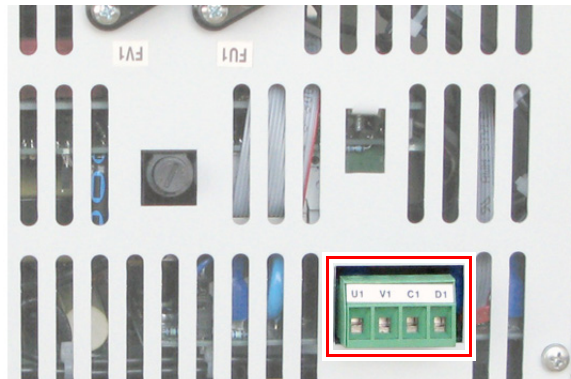

Frame C Field Circuit Terminal Block Location

230V/460V AC Input Frame C, Front View of Drive



575V/690V AC Input Frame C, Left Side of Drive

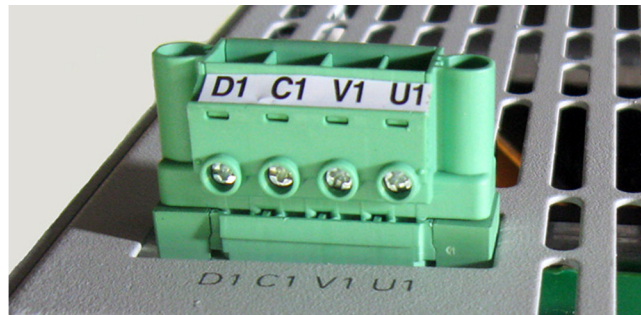

Frames A...C Field Circuit Wire Sizes and Terminal Specifications

Terminals	Wire Size and Type ⁽¹⁾	Tightening Torque N·m (lb·in)
U1, V1, C1, D1	24...10 AWG/kcmils	0.5...0.8 (4.4...7.1)

(1) For more information, see Cable and Wiring Recommendations in the PowerFlex Digital DC Drive User Manual, publication [20P-UM001](#).

Frame D Field Circuit Terminal Block Location

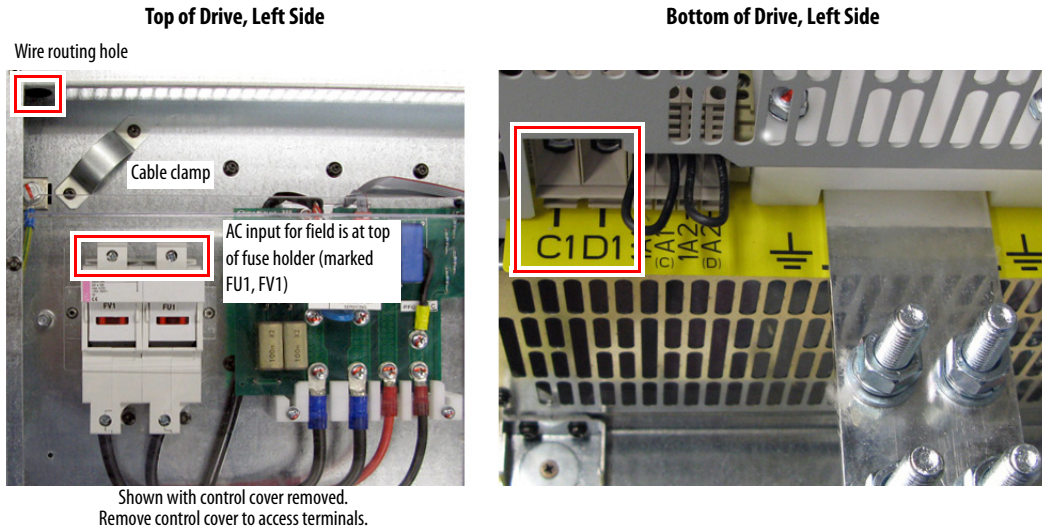

Frame D Field Circuit Wire Sizes and Terminal Specifications

Drive Current Rating Code ⁽¹⁾				Terminals	Wire Size ⁽²⁾	Tightening Torque N•m (lb•in)
230V	460V	575V	690V			
875	830	810	678	U1, V1, C1, D1	6 AWG	4.0 (35.4)
1K0	996	1K0	791			
—	—	1K2	904			
		1K3	1K0			
		1K6	—			
		1K1	1K1			
1K3	—	1K2	2 AWG			
1K4	—	1K4				
—	—	1K5				

(1) See [PowerFlex DC Drive Catalog Number Explanation on page 6](#), positions 8, 9 and 10 for corresponding drive Hp rating, armature Amp rating, and field Amp rating.
 (2) For more information, see Cable and Wiring Recommendations in the PowerFlex Digital DC Drive User Manual, publication [20P-UM001](#).

PowerFlex DC Drives and Field Controller Control Circuit Input Power

Supply power to the control circuit through an external 230V AC or 115V AC single-phase power supply. For frames B and C only, a jumper is required between terminals SA and SB for 115V AC control input power. See Frame B SA-SB Terminal Block Location (on all PowerFlex DC Drives and Field Controllers) on page [36](#) and Frame C SA-SB Terminal Block Location (only on PowerFlex DC Drives) on page [36](#) for terminal block locations.

Control Circuit Terminal Designations

Terminal	Description
U2	Single-phase AC power for the control circuits.
V2	

Frames A and B Control Circuit Terminal Block Location (on all PowerFlex DC Drives and Field Controllers)

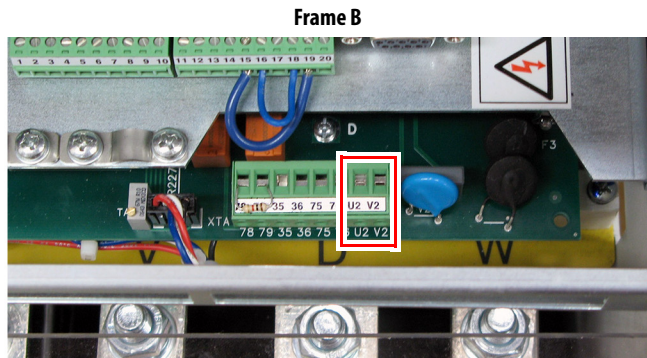
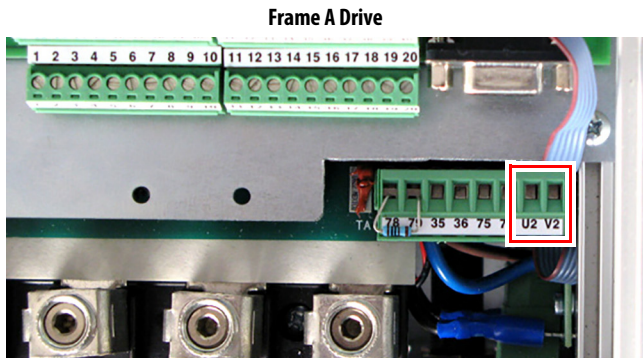

Frame C Control Circuit Terminal Block Location (only on PowerFlex DC Drives)

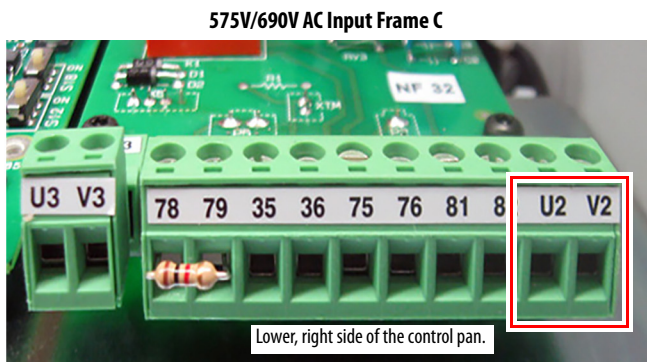
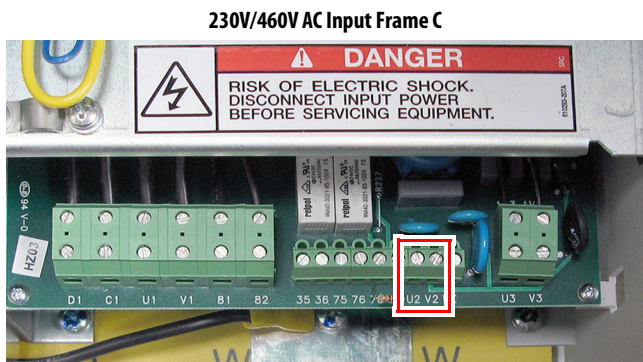

Frame D Control Circuit Terminal Block Location (only on PowerFlex DC Drives)

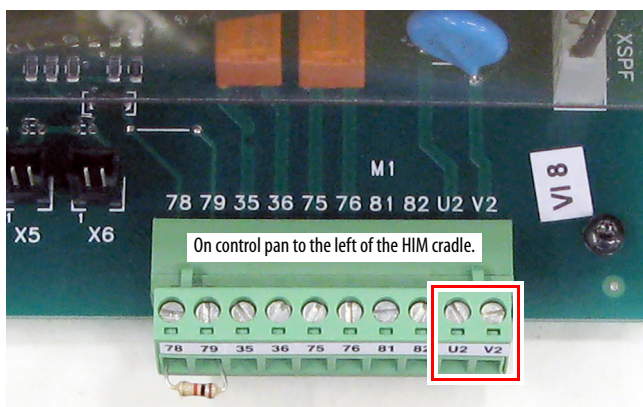

Control Circuit Wire Sizes

Terminals	Wire Size and Type ⁽¹⁾			Tightening Torque N-m (lb-in)
	Flexible (mm ²)	Multicore (mm ²)	AWG	
U2, V2	0.14...1.5	0.14...2.5	26...14	0.5 (4.4)
PE	2.5...10	2.5...10	12...8	2.0 (18.0)

(1) For more information, see Cable and Wiring Recommendations in the PowerFlex Digital DC Drive User Manual, publication [20P-UM001](#).

Frame B SA-SB Terminal Block Location (on all PowerFlex DC Drives and Field Controllers)

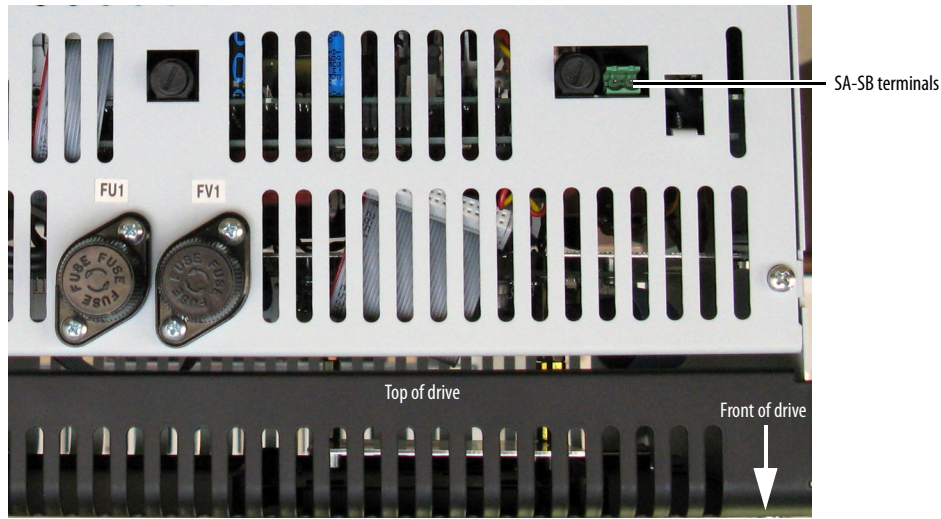

Frame C SA-SB Terminal Block Location (only on PowerFlex DC Drives)

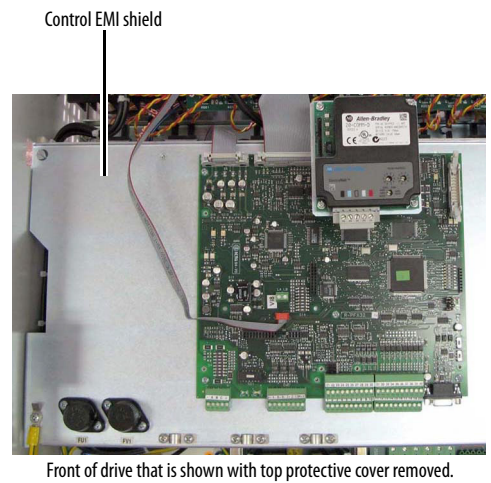
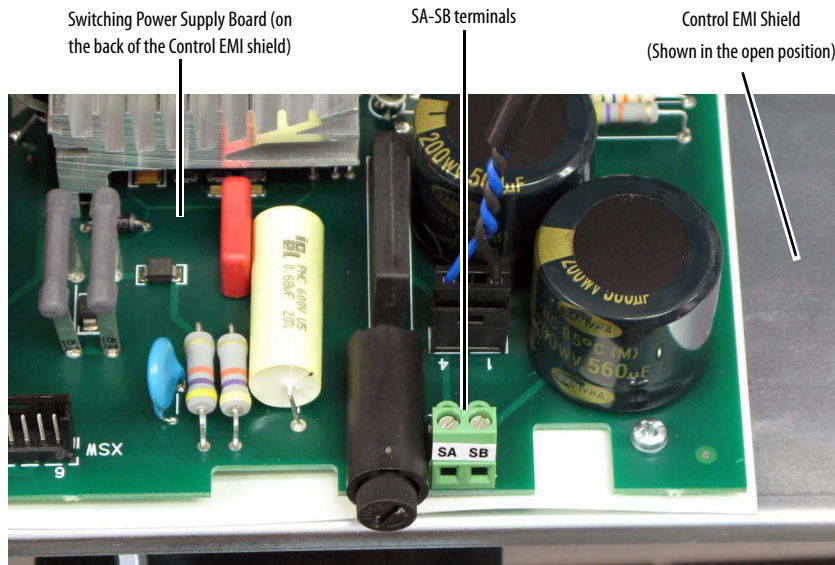

Frame C Heat Sink Cooling Fan Specifications

Frame C drives require an external 230V AC power supply for the heat sink cooling fans. If sourced from the main 3-phase AC input, the power supply connections must be taken from the primary side of the installed Isolation Transformer or Line Reactor (clean power).

In addition, the fan power input terminals U3 and V3 are required to be short-circuit protected. This protection can be provided by using a circuit breaker or fuses.

- If a circuit breaker is used, it must be rated for the short-circuit available current of the feeder source for this circuit and the inrush current of the fan. Size the circuit breaker to help protect the wiring from the circuit breaker connections to terminals U3 and V3, and not spurious trip or blow from the inrush current.
- If fuses are used, they must be rated for either 230V AC, 2.0 amps (slow blow).

Frame C Heat Sink Cooling Fans Terminal Designations

Terminal	Description	Max Voltage	Max Current
U3	Single-phase AC input power for cooling fans.	230V AC	1 A
V3			

Frame C Heat Sink Cooling Fans Wire Sizes and Terminal Specifications

Terminals	Wire Size and Type ⁽¹⁾			Tightening Torque N·m (lb·in)
	Flexible (mm ²)	Multicore (mm ²)	AWG	
U3, V3	0.14...1.5	0.14...2.5	26...16	0.4 (3.5)

(1) For more information, see Cable and Wiring Recommendations in the PowerFlex Digital DC Drive User Manual, publication [20P-UM001](#).

Frame C Heat Sink Cooling Fan Terminal Block Locations

230V/460V AC Input Frame C

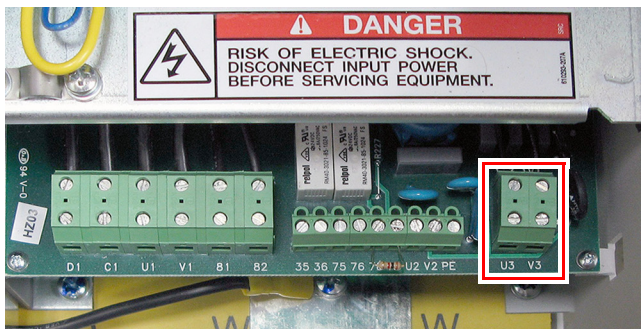

575V/690V AC Input Frame C

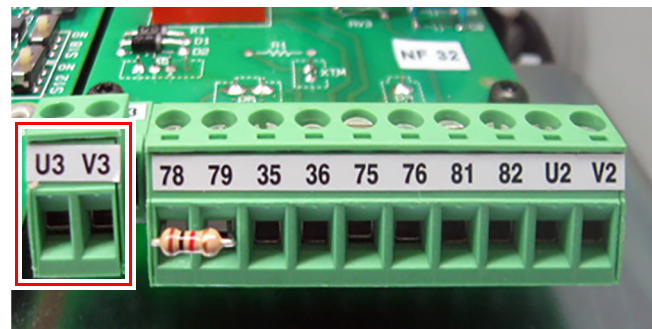

Frame D, Series B and C Heat Sink Cooling Fan Specifications

The frame D, series B and C drive cooling fan requires three-phase (50/60 Hz), 400...460V AC input power. If sourced from the main three-phase AC input, the power supply connections must be taken from the primary side of the installed isolation transformer or line reactor (clean power).

IMPORTANT When connecting the fan power wiring, verify that the airflow enters through the bottom and exits through the top of the drive. If the airflow is incorrect, switch the leads on terminals U3 and V3.

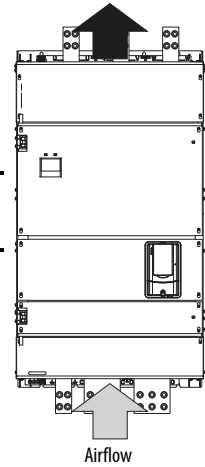

The cooling fan power input terminals U3, V3, and W3 are required to be short-circuit protected. This protection can be provided by using a circuit breaker or fuses.

- If a circuit breaker is used, it must be rated for the short-circuit available current of the feeder source for this circuit and the inrush current of the fan. Size the circuit breaker to help protect the wiring from the circuit breaker connections to terminals U3, V3, and W3, and not spurious trip or blow from the inrush current.
- If fuses are used, they must be rated for either 400V AC, 2.5 amps (slow blow), or 460V AC, 3.15 amps (slow blow).

A normally closed (N.C.) contact wired to terminals 31 and 32 of the fan terminal block can be connected to an external device to provide indication of a fan supply failure or can be wired to drive digital input terminals that are configured for 14 “Aux Fault” (via Pars 133...144).

Frame D, Series B and C Heat Sink Cooling Fan Terminal Designations

Terminal Block	Terminal	Description	AC Voltage	Max Current
	U3	Three-phase AC input power connections	400 . . . 460V AC (50/60 Hz)	1.5 A
	V3			
	W3			
	PE	Safety ground	—	—
	31	Normally closed contact	250V AC	1 A
	32			

Frame D, Series B and C Heat Sink Cooling Fan Signal Wire Sizes and Terminal Specifications

Terminals	Wire Size and Type ⁽¹⁾			Tightening Torque N·m (lb·in)
	Flexible (mm ²)	Multicore (mm ²)	AWG	
U3, V3, W3, 31, 32, PE	0.14 . . . 1.5	0.14 . . . 2.5	28 . . . 12	0.5 . . . 0.6 (4.4 . . . 5.3)

(1) For more information, see Cable and Wiring Recommendations in the PowerFlex Digital DC Drive User Manual, publication [20P-UM001](#).

Frame D, Series B and C Heat Sink Cooling Fan Terminal Block Location

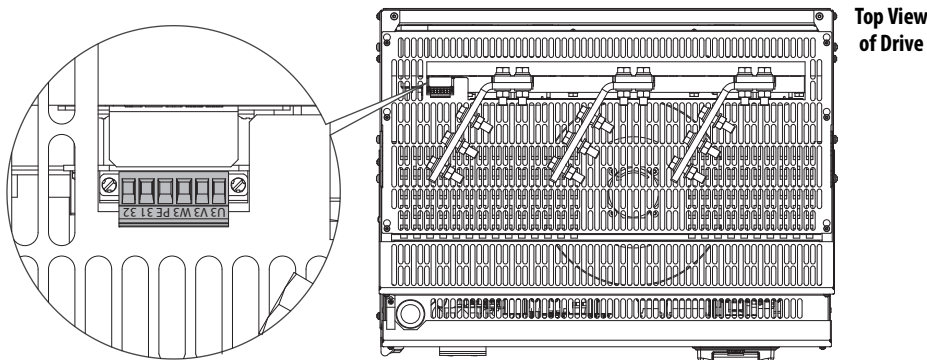

Frame C and D Armature Fuse Signal Terminals

Terminals 81 and 82 on frame C and D drives are connected to the internal armature circuit protection fuses and can be connected to an external device to provide indication that the fuses have opened. Alternatively, terminals 81 and 82 can be wired to drive digital input terminals that are configured for 64 “Invert Flt” (via Pars 133...144).

Armature Fuse Signal Terminal Designations

Terminal	Description	Maximum Voltage	Maximum Current
81	Internal armature fuse intervention signal.	250V AC	1 A
82			

Armature Fuse Signal Wire Size and Terminal Specifications

Terminals	Wire Size and Type ⁽¹⁾			Tightening Torque N-m (lb-in)
	Flexible (mm ²)	Multicore (mm ²)	AWG	
81, 82	0.14...1.5	0.14...2.5	26...16	0.4 (3.5)

(1) For more information, see Cable and Wiring Recommendations in the PowerFlex Digital DC Drive User Manual, publication [20P-UM001](#).

Frame C Internal Armature Fuse Signal Terminal Block Location



Frame D Internal Armature Fuse Signal Terminal Block Location

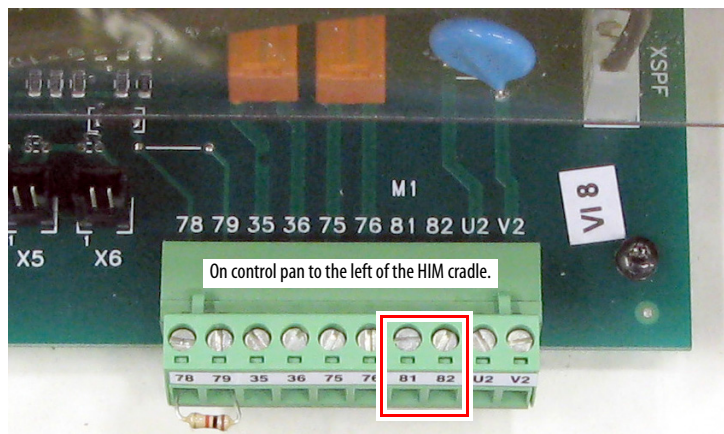

PowerFlex DC Drives and Field Controller Relay Outputs

Terminals 35 and 36 and 75 and 76 are N.O. relay outputs. The relay output between terminals 35 and 36 is configured with parameter 1392 [Relay Out 1 Sel]. The relay output between terminals 75 and 76 is configured with parameter 629 [Relay Out 2 Sel]. See “Using Contactors” in the PowerFlex Digital DC Drive User Manual, publication [20P-UM001](#), for more information.

PowerFlex DC Drives and Field Controller Thermistors and Thermal Switches

To detect motor overheating and protect the load from overloading, an external, user-supplied thermistor (PTC) or thermal switch must be connected to terminals 78 and 79. The response of the drive to a load over temperature fault is configured in parameter 365 [OverTemp Flt Cfg]. If a temperature sensor is not used, a 1 kΩ resistor must be connected between terminals 78 and 79 (installed at the factory). The instructions for installing a thermal sensor are detailed here.

Thermistors (PTC)

PTC thermistors that are fitted in the load can be connected directly to the drive via terminals 78 and 79. In this case, the 1 kΩ resistor is not required between terminals 78 and 79.

Thermal Switches (Klixon) in the Motor Windings

Klixon type temperature-dependent contacts can disconnect the drive from the load via an external control or can be configured as an external fault using a digital input on drive. They can also be connected to terminals 78 and 79 to indicate the following:

- For a PowerFlex DC drive, to indicate a drive “Motor Over Temp” fault (F16)
- For a PowerFlex DC field controller, to indicate a field controller “PTC Over Temp” fault (F16)

However, this configuration is not recommended due to the noise sensitivity of the current threshold circuitry. If a thermal switch is used, a 1 kΩ resistor must be placed in series between the switch and one of the terminals.

Contact Relay and Thermistor Terminal Designations

Terminal	Description
35	N.O. contact. Configured with parameter 1392 [Relay Out 1 Sel] - set to 25 “Contactor” by default.
36	
75	N.O. contact. Configured with parameter 629 [Relay Out 2 Sel] - set to 5 “Ready” by default.
76	
78	Motor thermistor connections (PTC)
79	

Frames A and B Contact Relay and Thermistor Terminal Block Locations

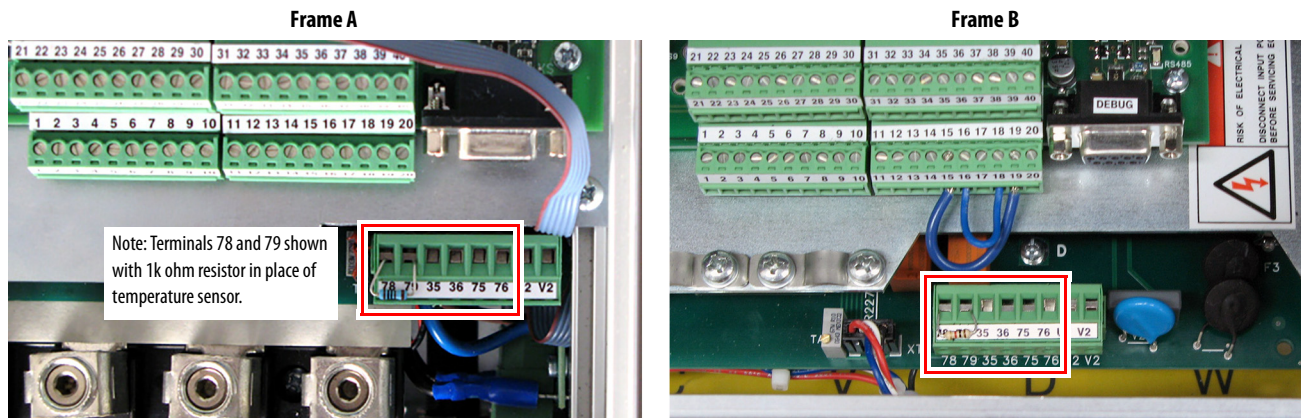

Frame C Contact Relay and Thermistor Terminal Block Locations (only for PowerFlex DC Drives)

230V/460V AC Input Frame C

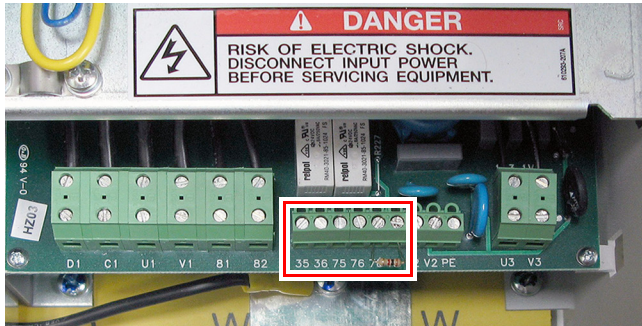

575V/690V AC Input Frame C

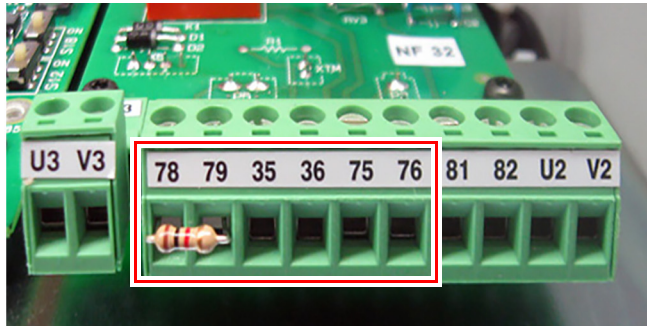

Frame D Contact Relay and Thermistor Terminal Block Locations (only for PowerFlex DC Drives)

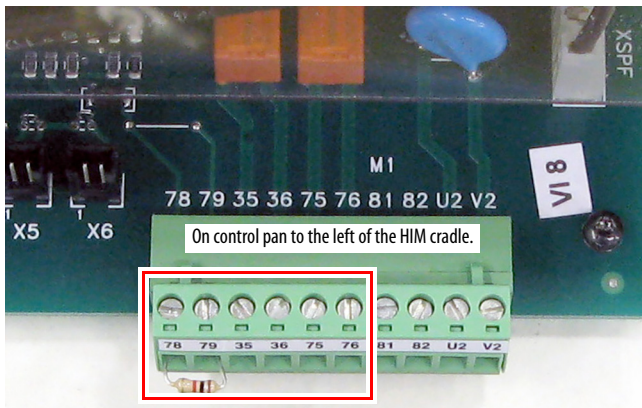

230V/460V AC Input Frame C

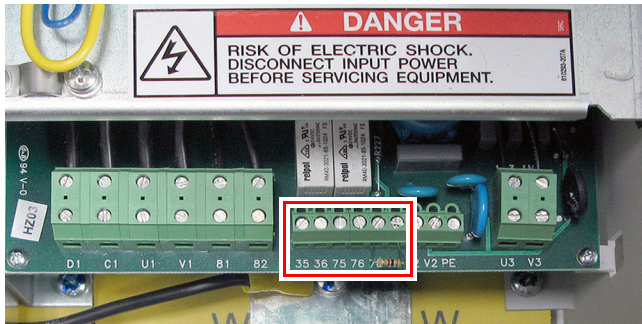

575V/690V AC Input Frame C

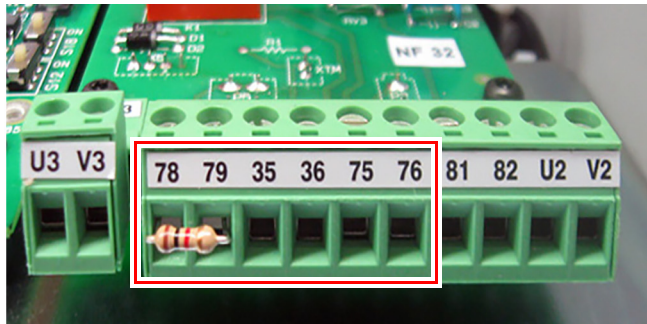

Recommended Signal Wire Size for Relay Outputs and Thermistor/Thermal Switch Terminals

Signal Type	Terminals	Wire Size and Type ⁽¹⁾			Tightening Torque N·m (lb-in)
		Flexible (mm ²)	Multicore (mm ²)	AWG	
Relay Outputs	35 & 36, 75 & 76	0.140...1.500	0.140...2.500	26...14	0.5 (4.4)
Thermistor and Thermal Switches	78 & 79				

(1) For more information, see Cable and Wiring Recommendations in the PowerFlex Digital DC Drive User Manual, publication [20P-UM001](#).

PowerFlex DC Drives and Field Controller I/O Signal and Control Wiring

Eight digital inputs, four digital outputs, three analog inputs, and two analog outputs are available on the standard I/O terminal blocks that are provided with the drive. One digital input (1...8) must be configured for "Enable".

More digital and analog I/O is available when using the optional I/O expansion circuit board. See Appendix F - 'Optional Analog and Digital I/O Expansion Circuit Board,' in the PowerFlex Digital DC Drive User Manual, publication [20P-UM001](#), for more information. You can also use the optional 115V AC converter circuit board to convert 115V AC to 24V DC digital inputs signals to interface with the digital inputs on the standard I/O terminal blocks. See Appendix G Optional 115V AC to 24V DC I/O Converter Circuit Board in the PowerFlex Digital DC Drive User Manual, publication [20P-UM001](#), for more information. All I/O terminal blocks are on the control board.

I/O Terminal Block Locations

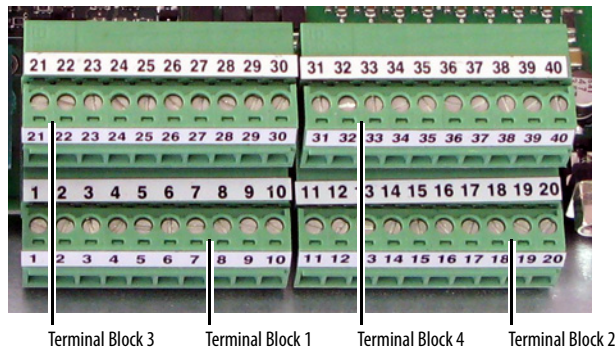

I/O Terminal Block 1 Designations

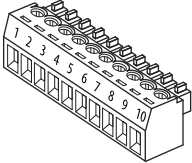
	No.	Signal	Description	Factory Default		Related Parameter
				DC Drive	Field Controller	
	1	Analog Input 1 (+)	Isolated ⁽¹⁾ , bipolar, differential, ±10V / 0...20 mA, or 4...20 mA. Important: 0...20 mA or 4...20 mA operation requires that switch S9, S10, and S11 on the Control board be in the "Off" position. Drive damage can occur if the switch is not in the correct position that is based on the type of input signal. See "DIP switch and Jumper Settings" in the PowerFlex Digital DC Drive User Manual, publication 20P-UM001 . Max ±10V, Max 0.25 mA.	1 "Speed Ref A"	5 "Current Ref A"	70 [Anlg In1 Sel]
	2	Analog Input 1 (-)		0 "Off"	75 [Anlg In2 Sel]	
	3	Analog Input 2 (+)		0 "Off"	80 [Anlg In3 Sel]	
	4	Analog Input 2 (-)				
	5	Analog Input 3 (+)				
	6	Analog Input 3 (-)				
	7	+10V Pot Reference	2...5k ohm load. Max ±10V, Max 10 mA.	—	—	
	8	-10V Pot Reference				
	9	Pot Common	For (+) and (-) 10V pot references.			
	10	PE ground	PE ground to drive chassis.			

(1) Differential Isolation - External source must be maintained at less than 160V with respect to PE. Input provides high common mode immunity.

I/O Terminal Block 2 Designations

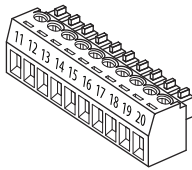
	No.	Signal	Description	Factory Default		Related Parameter
				DC Drive	Field Controller	
	11	Internal 0V		—	—	—
	12	Digital Input 1	Max Volt. +30V, Max Cur. 15V/3.2mA, 24V/5mA, and 30V/6.4mA.	2 "Stop/CF"		133 [Digital In1 Sel]
	13	Digital Input 2	A digital input (1...8) must be configured for "Enable".	3 "Start"		134 [Digital In2 Sel]
	14	Digital Input 3		11 "Jog"		135 [Digital In3 Sel]
	15	Digital Input 4		1 "Enable"		136 [Digital In4 Sel]
	16	Digital Input Common	Important: When using the internal +24V DC supply (terminal 19) for digital inputs 1...4, you must connect the digital input common (terminal 16) to the +24V supply common (terminal 18).	—	—	—
	17	Not Used				
	18	24V Supply Common	Common for the internal power supply.			
	19	Internal +24V DC Supply	Drive supplied +24V DC I/O power. Max. +20...30V, 200 mA Tip: The total current draw is the sum of encoder power, digital outputs, and any other loads that are connected to terminal 19.			
	20	PE ground	PE ground to drive chassis.			

I/O Terminal Block 3 Designations

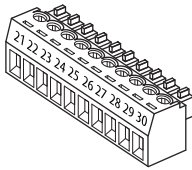
	No.	Signal	Description	Factory Default		Related Parameter
				DC Drive	Field Controller	
	21	Analog Output 1 (+)	Max. ±10V, Max. 5 mA.	12 "Motor Speed"	12 "Volt Fdbk"	66 [Anlg Out1 Sel]
	22	Analog Output 1 (-)				
	23	Analog Output 2 (+)		13 "Motor Curr"	13 "Output Curr"	67 [Anlg Out2 Sel]
	24	Analog Output 2 (-)				
	25	Digital Output Common		—	—	—
	26	Digital Output 1	Max. +30V, Max 50 mA	5 "Ready"		145 [Digital Out1 Sel]
	27	Digital Output 2		9 "Fault"		146 [Digital Out2 Sel]
	28	Digital Output 3		2 "Spd Thresh"	2 "Vlt Thresh"	147 [Digital Out3 Sel]
	29	Digital Output 4		4 "CurrentLimit"		148 [Digital Out4 Sel]
	30	Digital Output +24V DC Source	Tie point for the internal supply or customer supplied voltage for the digital outputs. Max. +30V DC, 80 mA. Important: When using the internal +24V DC supply (terminal 19) for digital outputs 1...4, you must connect terminal 19 to terminal 30 and the digital output common (terminal 25) to the +24V supply common (terminal 18).	—	—	—

I/O Terminal Block 4 Designations

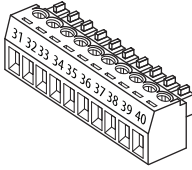
	No.	Signal	Description	Factory Default		Related Parameter
				DC Drive	Field Controller	
	31	Digital Input 5	Max Volt. +30V, Max Cur. 15V/3.2mA, 24V/5mA, and 30V/6.4mA.	17 "Speed Sel 1"	17 "Volt Sel 1"	137 [Digital In5 Sel]
	32	Digital Input 6		18 "Speed Sel 2"	18 "Volt Sel 2"	138 [Digital In6 Sel]
	33	Digital Input 7	A digital input (1...8) must be configured for "Enable".	19 "Speed Sel 3"	19 "Volt Sel 3"	139 [Digital In7 Sel]
	34	Digital Input 8		31 "Contactor"		140 [Digital In8 Sel]
	35	Digital Input Common	Important: When using the internal +24V DC supply (terminal 19) for digital inputs 5...8, you must connect the digital input common (terminal 35) to the +24V supply common (terminal 18).	—	—	—
	36	Not Used				
	...					
	40					

Recommended Signal Wire Size for Analog I/O and Digital I/O

Signal Type	Terminal Block (Terminals)	Wire Size and Type ⁽¹⁾			Tightening Torque N·m (lb·in)
		Flexible (mm ²)	Multicore (mm ²)	AWG	
Analog and Digital I/O	TB1...4 (1...40)	0.140...1.500	0.140...1.500	26...16	0.4 (3.5)

(1) For more information, see Cable and Wiring Recommendations in the PowerFlex Digital DC Drive User Manual, publication [20P-UM001](#).

PowerFlex DC Drives Digital Encoder Terminal Block

Always connect the encoder connection cables directly to the terminals on the encoder terminal block. The encoder cable must be composed of twisted pairs with the shield connected to the shield ground on the drive side. Do not connect the shield to ground on the motor side. In some cases (that is, cable lengths that exceed 100 meters), it can be necessary to ground the shield of each twisted-pair on the power supply. See Appendix A of the PowerFlex Digital DC Drive User Manual, publication [20P-UM001](#), for Digital Encoder specifications.

Digital Encoder Terminal Designations

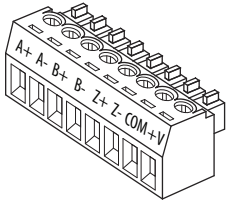
Terminal Block	Label	Signal	Description
	A+	Encoder A	Single channel or quadrature A input
	A-	Encoder A (NOT)	
	B+	Encoder B	Dual channel quadrature B input
	B-	Encoder B (NOT)	
	Z+	Encoder Z	Pulse, marker, or registration input ⁽²⁾
	Z-	Encoder Z (NOT)	
	COM	+5/12...15V ⁽¹⁾ DC Return	Internal power common
	+V	+5/12...15V ⁽¹⁾ DC Power	Internal power source 200 mA

(1) Selectable via switch S21 on the Control board. See "DIP Switch and Jumper Settings" in the PowerFlex Digital DC Drive User Manual, publication [20P-UM001](#), for more information.

(2) Selectable via switch S20 on the Control board. See "DIP Switch and Jumper Settings" in the PowerFlex Digital DC Drive User Manual, publication [20P-UM001](#), for more information.

Digital Encoder Terminal Block Location

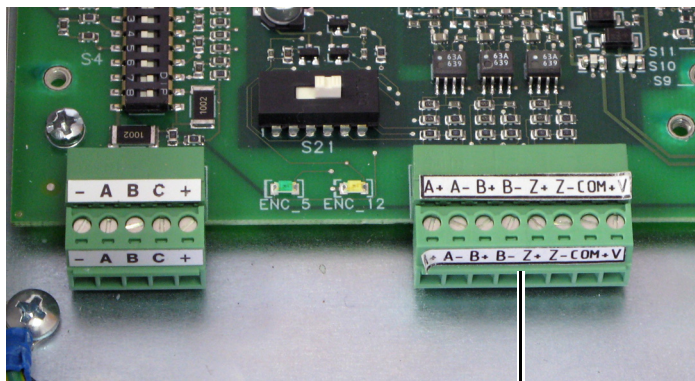

Digital Encoder terminal block

Sample Encoder Power Wiring

Power Source	Connection Example
<p>Internal Drive Power ⁽¹⁾ Internal (drive) +5/12...15V DC, 200 mA</p>	
<p>External Power Source</p>	

(1) Shield connection is on the drive Control EMI Shield. See [Digital Encoder Terminal Block Location on page 44](#).

Sample Encoder Signal Wiring

Encoder Signal	Connection Example
<p>Single-Ended, Dual Channel</p>	
<p>Differential, Dual Channel</p>	

PowerFlex DC Drives DC Analog Tachometer Terminal Block



ATTENTION: The drive can overspeed if DIP switch S4 is set incorrectly, or the tachometer is wired incorrectly. Failure to do so could result in damage to, or destruction of, the equipment.

DC Analog Tachometer Terminal Designations

No.	Signal	Description
-	Negative input	-
A	(Not Used)	
B		
C		
+	Positive input Feedback polarity is determined during the startup routine.	22.7 / 45.4 / 90.7 / 181.6 / 302.9V ⁽¹⁾ max voltage 8 mA max current

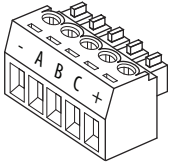

(1) Maximum voltage depends on the configuration of DIP switch S4. For information on jumper settings, see the PowerFlex® Digital DC Drive User Manual, publication [20P-UM001](#).

Analog Tachometer Terminal Block Location

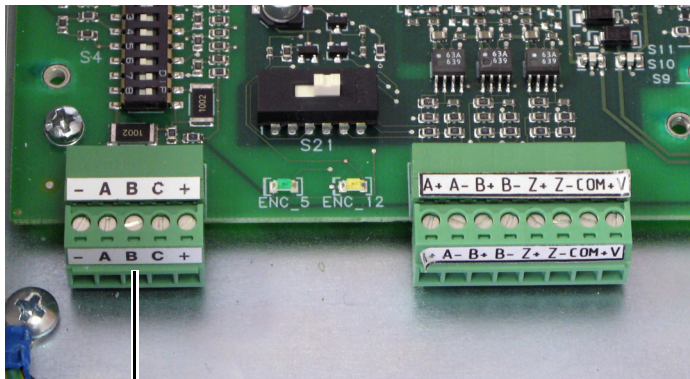

Analog Tachometer terminal block

Recommended Signal Wire Size for DC Analog Tachometer

Signal Type	Terminal Block (Terminals)	Wire Type and Size ⁽¹⁾			Tightening Torque N·m (lb-in)
		Flexible (mm ²)	Multicore (mm ²)	AWG	
DC Analog Tach	M3 (+ and -)	0.140...1.500	0.140...1.500	26...16	0.4 (3.5)

(1) See Cable and Wiring Recommendations in the PowerFlex Digital DC Drive User Manual, publication [20P-UM001](#).

PowerFlex DC Drives Resolver Feedback Module

The resolver feedback module (catalog number 20P-RES-A0), which provides a drive interface to a selection of compatible resolvers, must be ordered and purchased separately from the drive. The resolver option module includes the PowerFlex DC Drive Resolver Feedback Module Installation Instructions, publication [20P-IN071](#), which provides installation and wiring information. See ‘Resolver Type Selection’ in the PowerFlex Digital DC Drive User Manual, publication [20P-UM001](#), for more information on compatible resolvers.

PowerFlex DC Drives and Field Controller Circuit Protection

The tables on the following pages provide the fuses that are required to help protect the armature and field circuits. Externally mounted fuses (as indicated in Frame A and B Fuse Designations) must be sourced separately when installing the drive. Internally mounted fuses are provided with the drive. See page 53 for frames C and D fuse information.

PowerFlex DC Drives Frame A and B Fuse Information

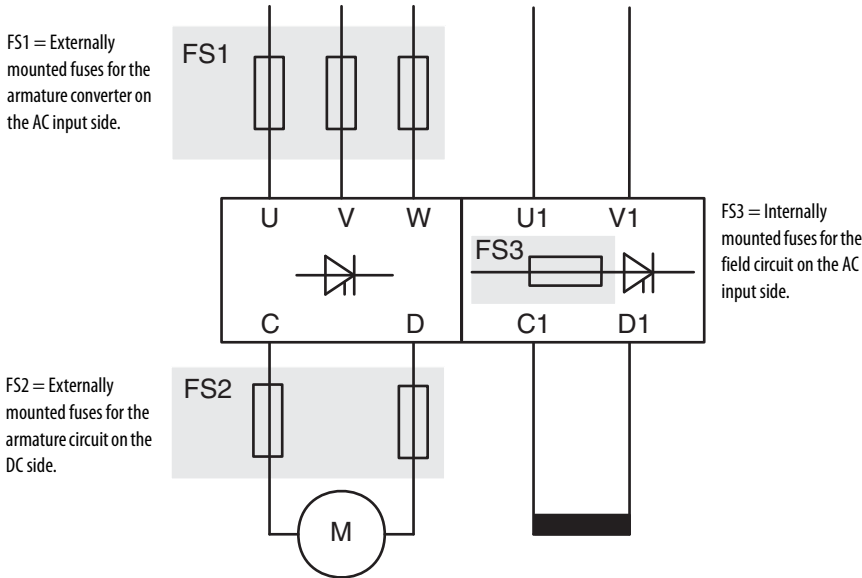

PowerFlex DC Drives Frames A and B AC Input Line Fuses

AC input line fuses are externally mounted for frame A and B drives and must be sourced separately. See Fuse Code FS1 in PowerFlex DC Drives Frame A and B Fuse Information on page 47.

230V AC Input Drives

Frame	Drive Current Rating Code	DC Amps	AC Line Amps	Bussmann		Mersen	
				Ferrule FWP Type	North American FWP Type	Ferrule A70QS Type	North American A70P / A70QS Type
A	7P0	7	5.7	FWP-10A14F	FWP-10B	A70QS10-14F	A70P10-4
	9P0	9	7.4	FWP-15A14F	FWP-15B	A70QS16-14F	A70P15-4
	012	12	9.8	FWP-20A14F	FWP-20B	A70QS20-14F	A70P20-4
	020	20	16	FWP-25A14F	FWP-25B	A70QS25-14F	A70P25-4
	029	29	24	FWP-40A22F	FWP-40B	A70QS40-22F	A70QS40-4
	038	38	31	FWP-63A22F	FWP-60B	A70QS63-22F	A70QS60-4
	055	55	45	FWP-80A22F	FWP-80B	A70QS80-22F	A70QS80-4
	073	73	60	—	FWP-100A	—	A70QS100-4K
	093	93	76		FWP-150A		A70QS150-4K
110	110	90	FWP-175A		A70QS175-4K		
B	146	146	119	—	FWP-250A	—	A70QS250-4
	180	180	147		FWP-300A		A70QS300-4
	218	218	178		FWP-350A		A70QS350-4
	265	265	217		FWP-400A		A70QS400-4
	360	360	294		FWP-600A		A70QS600-4K
	434	434	355		FWP-600A		A70QS600-4

460V AC Input Drives

Frame	Drive Current Rating Code	DC Amps	AC Line Amps	Bussmann		Mersen	
				Ferrule FWP Type	North American FWP Type	Ferrule A70QS Type	North American A70P / A70QS Type
A	4P1	4.1	3.3	FWP-10A14F	FWP-10B	A70QS10-14F	A70P10-4
	6P0	6	4.9	FWP-10A14F	FWP-10B	A70QS10-14F	A70P10-4
	010	10	8.2	FWP-20A14F	FWP-20B	A70QS20-14F	A70P25-4
	014	14	11.4	FWP-25A14F	FWP-25B	A70QS25-14F	A70P25-4
	019	19	15.5	FWP-25A14F	FWP-25B	A70QS25-14F	A70P25-4
	027	27	22.1	FWP-40A22F	FWP-40B	A70QS40-22F	A70QS40-4
	035	35	28.6	FWP-63A22F	FWP-60B	A70QS63-22F	A70QS60-4
	045	45	36.8	FWP-80A22F	FWP-80B	A70QS80-22F	A70QS80-4
	052	52	42.5	FWP-80A22F	FWP-80B	A70QS80-22F	A70QS80-4
	073	73	59.6	—	FWP-100A	—	A70QS100-4K
	086	86	70.3		FWP-150A		A70QS150-4K
	100	100	81.7		FWP-175A		A70QS175-4K
	129	129	105.4		FWP-175A		A70QS175-4K
	167	167	136.4		FWP-300A		A70QS300-4
207	207	169.1	FWP-350A		A70QS350-4		
B	250	250	204.3	FWP-400A	A70QS400-4		
	330	330	269.6	FWP-600A	A70QS600-4K		
	412	412	336.6	FWP-600A	A70QS600-4		

575V AC Input Drives

Frame	Drive Current Rating Code	DC Amps	AC Line Amps	Bussmann	Mersen
				North American FWP Type	North American A70QS Type
B	067	67.5	55.1	FWP-100A	A70QS100-4
	101	101.3	82.7	FWP-175A	A70QS175-4K
	135	135	110.3	FWP-225A	A70QS225-4
	270	270	220.6	FWP-450A	A70QS450-4
	405	405	330.9	FWP-600A	A70QS600-4K

Frame A and B Armature DC Output Fuses

Armature DC output fuses are externally mounted for frame A and B drives and must be sourced separately. These fuses are required on four quadrant drives only, but highly recommended on two quadrant drives. See Fuse Code FS2 in PowerFlex DC Drives Frame A and B Fuse Information on page [47](#).

230V AC Input Drives

Frame	Drive Current Rating Code	DC Amps	AC Line Amps	Bussmann		Mersen	
				Ferrule FWP Type	North American FWP Type	Ferrule A70QS Type	North American A70P / A70QS Type
A	7P0	7	5.7	FWP-15A14F	FWP-15B	A70QS16-14F	A70P15-4
	9P0	9	7.4	FWP-20A14F	FWP-20B	A70QS20-14F	A70P20-4
	012	12	9.8	FWP-25A14F	FWP-25B	A70QS25-14F	A70P25-4
	020	20	16	FWP-40A14F	FWP-40B	A70QS40-14F	A70QS40-4
	029	29	24	FWP-63A22F	FWP-60B	A70QS63-22F	A70QS60-4
	038	38	31	FWP-80A22F	FWP-80B	A70QS80-22F	A70QS80-4
	055	55	45	–	FWP-125A	–	A70QS125-4K
	073	73	60	–	FWP-150A	–	A70QS150-4K
	093	93	76	–	FWP-200A	–	A70QS200-4K
	110	110	90	–	FWP-225A	–	A70QS250-4
B	146	146	119	–	FWP-300A	–	A70QS300-4
	180	180	147	–	FWP-350A	–	A70QS350-4
	218	218	178	–	FWP-450A	–	A70QS450-4
	265	265	217	–	FWP-600A	–	A70QS600-4K
	360	360	294	–	FWP-700A	–	A70QS700-4
	434	434	355	–	FWP-900A	–	A70P900-4

460V AC Input Drives

Frame	Drive Current Rating Code	DC Amps	AC Line Amps	Bussmann		Mersen	
				Ferrule FWP Type	North American FWP Type	Ferrule A70QS Type	North American A70P / A70QS Type
A	4P1	4.1	3.3	FWP-10A14F	FWP-10B	A70QS10-14F	A70P10-4
	6P0	6	4.9	FWP-15A14F	FWP-15B	A70QS16-14F	A70P15-4
	010	10	8.2	FWP-20A14F	FWP-20B	A70QS20-14F	A70P20-4
	014	14	11.4	FWP-30A14F	FWP-30B	A70QS32-14F	A70P30-4
	019	19	15.5	FWP-40A14F	FWP-40B	A70QS40-14F	A70QS40-4
	027	27	22.1	FWP-63A22F	FWP-60B	A70QS63-22F	A70QS60-4
	035	35	28.6	FWP-80A22F	FWP-70B	A70QS80-22F	A70QS70-4
	045	45	36.8	FWP-100A22F	FWP-90B	–	A70QS90-4
	052	52	42.5	FWP-100A22F	FWP-100B	–	A70QS100-4
	073	73	59.6	–	FWP-150A	–	A70QS150-4K
	086	86	70.3	–	FWP-175A	–	A70QS175-4K
	100	100	81.7	–	FWP-200A	–	A70QS200-4K
	129	129	105.4	–	FWP-250A	–	A70QS250-4
	B	167	167	136.4	–	FWP-350A	–
207		207	169.1	–	FWP-400A	–	A70QS400-4
250		250	204.3	–	FWP-500A	–	A70QS500-4K
330		330	269.6	–	FWP-700A	–	A70QS700-4
412		412	336.6	–	FWP-800A	–	A70QS800-4

575V AC Input Drives

Frame	Drive Current Rating Code	DC Amps	AC Line Amps	Bussmann	Mersen
				North American FWP Type	North American A70P / A70QS Type
B	067	67.5	55.1	FWP-125A	A70QS125-4K
	101	101.3	82.7	FWP-200A	A70QS200-4K
	135	135	110.3	FWP-250A	A70QS250-4
	270	270	220.6	FWP-600A	A70QS600-4K
	405	405	330.9	FWP-800A	A70QS800-4

Field Controller Frames A and B AC Input Line Fuses

AC input line fuses are externally mounted for frame A and B drives and must be sourced separately.

Cat. No.	Frame Size	DC Amps	AC Line Amps	Bussman		Mersen	
				Ferrule FWP Type	North American FWP Type	Ferrule A70QS Type	North American A70P / A70QS Type
23PFCx017	A	17	14	FWP-25A14F	FWP-25B	A70QS25-14F	A70P25-4
23PFCx060		60	49	FWP-80A22F	FWP-80B	A70QS80-22F	A70QS80-4
23PFCx120		120	98	—	FWP-150A	—	A70QS150-4K
23PFCx245	B	245	201		FWP-300A		A70QS300-4
23PFCx365		365	299		FWP-400A		A70QS400-4
23PFCx570		570	467		FWP-600A		A70QS600-4

PowerFlex DC Drive Frame A and B Field Circuit Fuses

Field circuit fuses are internally mounted and provided with the drive. See Fuse Code FS3 in PowerFlex DC Drives Frame A and B Fuse Information on page 47. Also, see PowerFlex DC Drive Frame A Field AC Input Line Fuses Location on page 52 and PowerFlex DC Drive Frame B Field AC Input Line Fuses Location on page 52 for fuse locations.

230V AC Input Drives

Frame	Drive Current Rating Code	Field Amps	Type	Quantity	Bussmann	Mersen	SIBA
A	7P0	10	6 x 32 mm	2	FWH-016A6F	E085449	70 125 40.16
	9P0						
	012						
	020						
	029						
	038						
	055						
	073	14					
	093						
	110						

Frame	Drive Current Rating Code	Field Amps	Type	Quantity	Bussmann	Mersen	SIBA
B	146	20	10 x 38 mm	2	FWC-25A10F	A60Q25-2	60 033 05.25
	180						
	218						
	265						
	360						
	434						

460V AC Input Drives

Frame	Drive Current Rating Code	Field Amps	Type	Quantity	Bussmann	Mersen	SIBA
A	4P1	10	6 x 32 mm	2	FWH-016A6F	E085449	70 125 40.16
	6P0						
	010						
	014						
	019						
	027						
	035						
	045	14					
	052						
	073						
	086						
	100						
	129						
B	167	20	10 x 38 mm	2	FWC-25A10F	A60Q25-2	60 033 05.25
	207						
	250						
	330						
	412						

575V AC Input Drives

Frame	Drive Current Rating Code	Field Amps	Type	Quantity	Bussmann	Mersen	SIBA
B	067	20	10 x 38 mm	2	FWC-25A10F	A60Q25-2	60 033 05.25
	101						
	135						
	270						
	405						

PowerFlex DC Drive Frame A Field AC Input Line Fuses Location

Bottom View of Drive with Fan

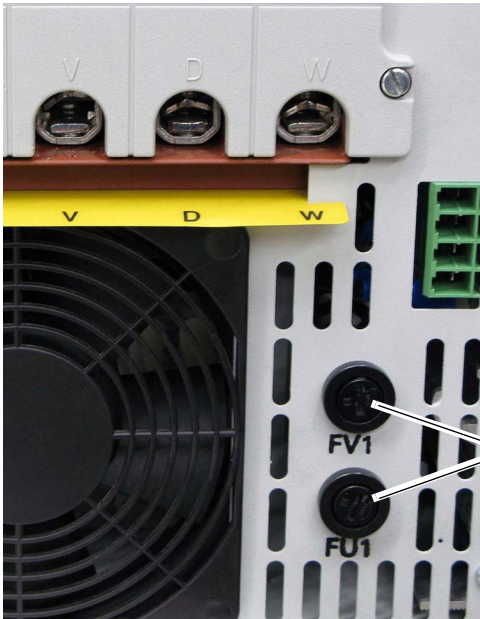

Bottom View of Drive without Fan

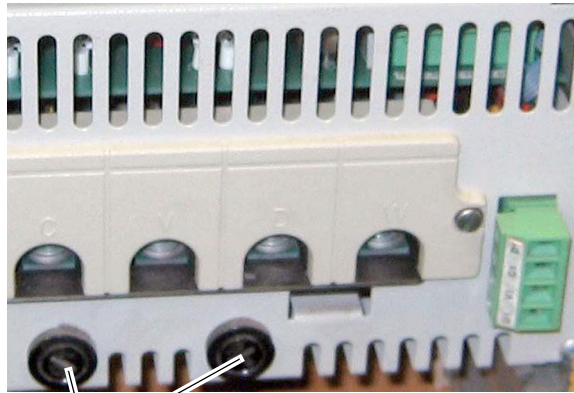

Field circuit fuses

PowerFlex DC Drive Frame B Field AC Input Line Fuses Location

Top View of Drive

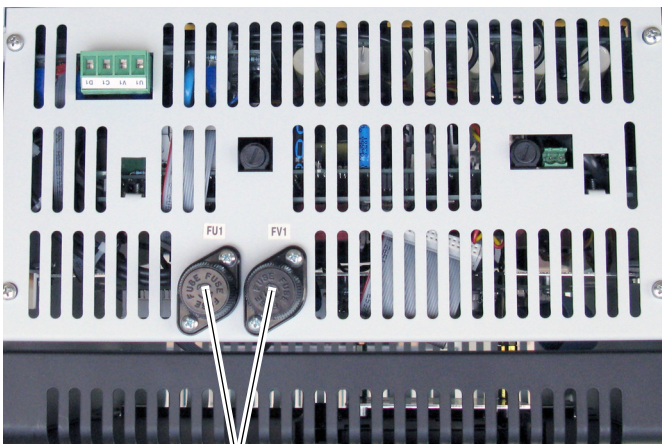

Field circuit fuses

PowerFlex DC Drive Frame C and D Fuse Information

All fuses for armature and field circuit protection are internally mounted and provided with frame C and D drives.

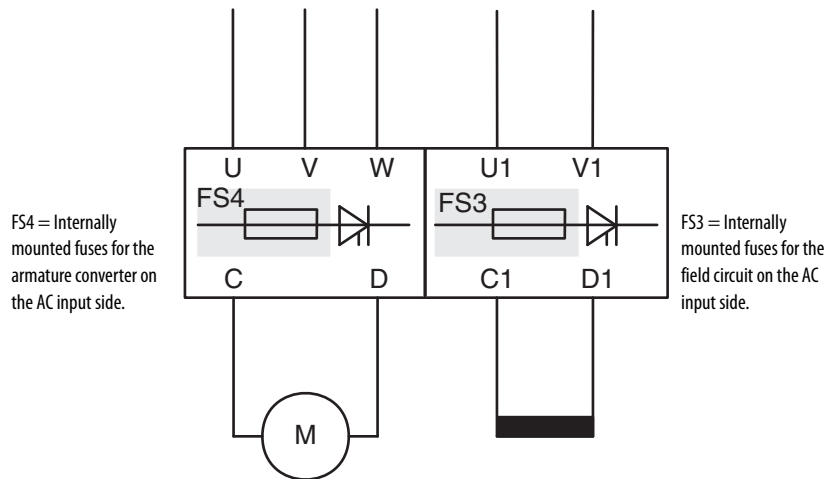

Frame C and D Field Circuit Fuses

Field circuit fuses for frames C and D drives are internally mounted (labeled FU1 and FV1) and provided with the drive. See Fuse Code FS3 in PowerFlex DC Drive Frame C and D Fuse Information on page 53. Also, see PowerFlex DC Frame C and D Drives Field Circuit Fuse Locations on page 54 and Fuses for Regenerative Frame C and D Drives on page 54 for locations.

230V AC Input Drives

Frame	Drive Current Rating Code	Field Amps	Type	Qty	Bussmann	Mersen	SIBA
C	521	20	10 x 38 mm	2	FWC-25A10F	A60Q25-2	6003305.25
D	875 1K0	40	22 x 58 mm		FWP-50A22F	A70QS50-22F	5014006.50

460V AC Input Drives

Frame	Drive Current Rating Code	Field Amps	Type	Qty	Bussmann	Mersen	SIBA
C	495 667	20	10 x 38 mm	2	FWC-25A10F	A60Q25-2 A60Q25-8	6003305.25
D	830 996 1K1 1K3 1K4	40 70	22 x 58 mm			FWP-50A22F FWP-100A22F	

575V AC Input Drives

Frame	Drive Current Rating Code	Field Amps	Type	Qty	Bussmann	Mersen	SIBA
C	540 675	20	10 x 38 mm	2	FWC-25A10F	A60Q25-2 A60Q25-8	6003305.25
D	810 1K0 1K2 1K3 1K6	40	22 x 58 mm			FWP-50A22F	

690V AC Input Drives

Frame	Drive Current Rating Code	Field Amps	Type	Qty	Bussmann	Mersen	SIBA
C	452	20	10 x 38 mm	2	FWC-25A10F	A60Q25-2	6003305.25
	565					A60Q25-8	
D	678	40	22 x 58 mm	2	FWP-50A22F	A70QS50-22F	5014006.50
	791						
	904						
	1K0						
	1K1	70			FWP-100A22F	A70QS100-22F	5014006.100
	1K2						
	1K4						
	1K5						

PowerFlex DC Frame C and D Drives Field Circuit Fuse Locations

Frame C Drive

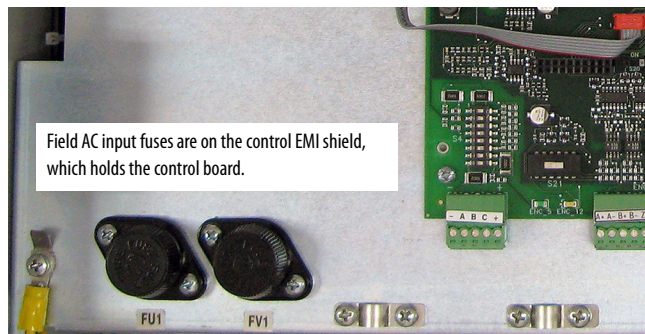

Frame D Drive

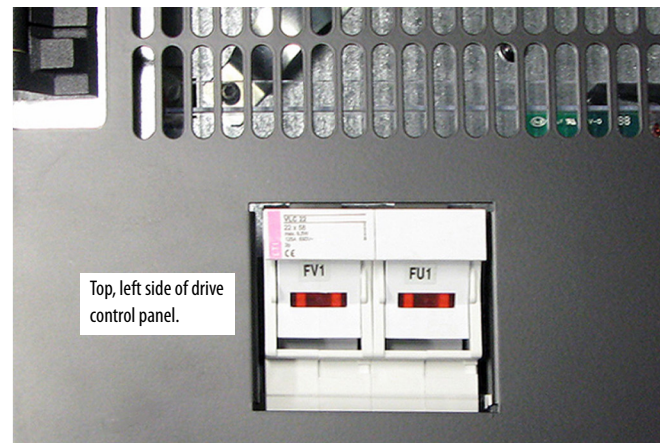

Fuses for Regenerative Frame C and D Drives

Leg fuses are internally mounted and provided with frames C and D drives. See Fuse Code FS4 in PowerFlex DC Drive Frame C and D Fuse Information on page 53. Also, see Frame C Regenerative Drive - Leg Fuse Location and Frame D Regenerative Drive - Leg Fuse Location on page 56.

Leg Fuses - 230V AC Input Frame C Drives

Frame	Drive Current Rating Code	DC Amps	AC Line Amps	Qty	Bussmann	Mersen	SIBA
					Square Body - Flush End Contact		
C	521	521	426	6	170M5464 + switch 170H0069	6,9 URD 32 TTF 800 + switch MS 3-V1-5 BS	20 671 32.800 + switch 28 001 04
	700	700	571				

Leg Fuses - 230V AC Input Frame D Drives

Frame	Drive Current Rating Code	DC Amps	AC Line Amps	Qty	Bussmann	Mersen	SIBA
					Square Body - DIN 43653 Stud-Mount		
D	875	875	715	6	170M6263 + switch 170H0069	Y300263 + switch MS 3V 1-5 UR	20 635 32.900 + switch 28 001 04
	1K0	1050	858				

Leg Fuses - 460V AC Input Frame C Drives

Frame	Drive Current Rating Code	DC Amps	AC Line Amps	Qty	Bussmann	Mersen	SIBA
					Square Body - Flush End Contact		
C	495	495	404.4	6	170M5462 + switch 170H0069	6,9 URD 32 TTF 630 + switch MS 3-V1-5 BS	20 671 32.630 + switch 28 001 04
	667	667	544.9				

Leg Fuses - 460V AC Input Frame D Drives

Frame	Drive Current Rating Code	DC Amps	AC Line Amps	Qty	Bussmann	Mersen	SIBA
					Square Body - DIN 43653 Stud-Mount		
D	830	830	678.1	6	170M6262 + switch 170H0069	X300262 + switch MS 3V 1-5 UR	20 635 32.800 + switch 28 001 04
	996	996	813.7		170M6264 + switch 170H0069	Z300264 + switch MS 3V 1-5 UR	20 635 32.1000 + switch 28 001 04
	1K1	1162	949.4		170M6265 + switch 170H0069	A300262 + switch MS 3V 1-5 UR	20 635 32.1100 + switch 28 001 04
	1K3	1328	1085.0		170M6266 + switch 170H0069	B300266 + switch MS 3V 1-5 UR	20 635 32.1250 + switch 28 001 04
	1K4	1494	1220.6		170M6267 + switch 170H0069	C300267 + switch MS 3V 1-5 UR	20 635 32.1400 + switch 28 001 04

Leg Fuses - 575V AC Input Frame C Drives

Frame	Drive Current Rating Code	DC Amps	AC Line Amps	Qty	Bussmann	Mersen	SIBA
					Square Body - Flush End Contact		
C	540	540	441	6	—	11 URD 72 TTF 0800 + switch MS 3V 1-5 BS	20 771 32.800 + switch 28 001 04
	675	675	551		—	11 URD 72 TTF 0800 + switch MS 3V 1-5 BS	20 771 32.800 + switch 28 001 04

Leg Fuses - 575V AC Input Frame D Drives

Frame	Drive Current Rating Code	DC Amps	AC Line Amps	Qty	Bussmann	Mersen	SIBA
					Square Body - DIN 43653 Stud-Mount		
D	810	810	661	6	170M6246 + switch 170H0069	J300572 + switch MS 3V 1-5 UR	20 735 32.800 + switch 28 001 04
	1K0	1080	881		170M6248 + switch 170H0069	L300574 + switch MS 3V 1-5 UR	20 735 32.1000 + switch 28 001 04
	1K2	1215	991	12	170M6244 + switch 170H0069	G300570 + switch MS 3V 1-5 UR	20 735 32.630 + switch 28 001 04
	1K3	1350	1102		170M6245 + switch 170H0069	H300571 + switch MS 3V 1-5 UR	20 735 32.700 + switch 28 001 04
	1K6	1688	1377		170M6246 + switch 170H0069	J300572 + switch MS 3V 1-5 UR	20 735 32.800 + switch 28 001 04

Leg Fuses - 690V AC Input Frame C Drives

Frame	Drive Current Rating Code	DC Amps	AC Line Amps	Qty	Bussmann	Mersen	SIBA
					Square Body - Flush End Contact		
C	452	452	369	6	170M5394 + switch 170H0069	12,5 URD 72 TTF 0500 + switch MS 3V 1-5 BS	20 771 32.500 + switch 28 001 04
	565	565	461		—	12,5 URD 72 TTF 0630 + switch MS 3V 1-5 BS	20 771 32.630 + switch 28 001 04

Leg Fuses - 690V AC Input Frame D Drives

Frame	Drive Current Rating Code	DC Amps	AC Line Amps	Qty	Bussmann	Mersen	SIBA
					Square Body - DIN 43653 Stud-Mount		
D	678	678	553	6	170M6244 + switch 170H0069	G300570 + switch MS 3V 1-5 UR	20 735 32.630 + switch 28 001 04
	791	791	645		170M6246 + switch 170H0069	J300572 + switch MS 3V 1-5 UR	20 735 32.800 + switch 28 001 04
	904	904	738		170M6247 + switch 170H0069	K300573 + switch MS 3V 1-5 UR	20 735 32.900 + switch 28 001 04
	1K0	1017	830	12	170M6248 + switch 170H0069	L300574 + switch MS 3V 1-5 UR	20 735 32.1000 + switch 28 001 04
	1K1	1130	922		170M6244 + switch 170H0069	G300570 + switch MS 3V 1-5 UR	20 735 32.630 + switch 28 001 04
	1K2	1243	1014		170M6244 + switch 170H0069	G300570 + switch MS 3V 1-5 UR	20 735 32.630 + switch 28 001 04
	1K4	1413	1153		170M6245 + switch 170H0069	H300571 + switch MS 3V 1-5 UR	20 735 32.700 + switch 28 001 04
	1K5	1582	1291		170M6246 + switch 170H0069	J300572 + switch MS 3V 1-5 UR	20 735 32.800 + switch 28 001 04

Frame C Regenerative Drive - Leg Fuse Location

Note: Drive shown with front covers removed and Control EMI shield lowered.

Leg fuses and switches are on the busbars behind the Control EMI shield, which holds the Control board.

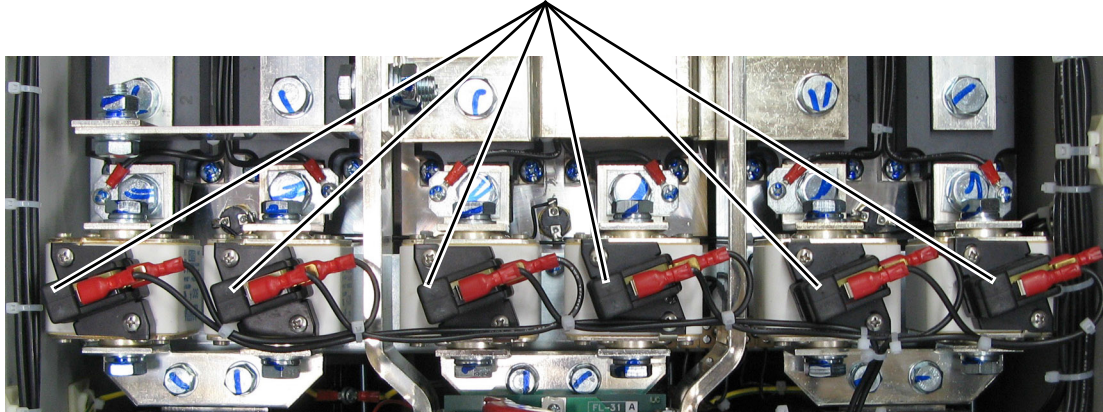

Frame D Regenerative Drive - Leg Fuse Location

Note: Drive shown with Control EMI shield in open position.

Leg fuses and switches are on the busbars behind the Control EMI shield, which holds the Control board.

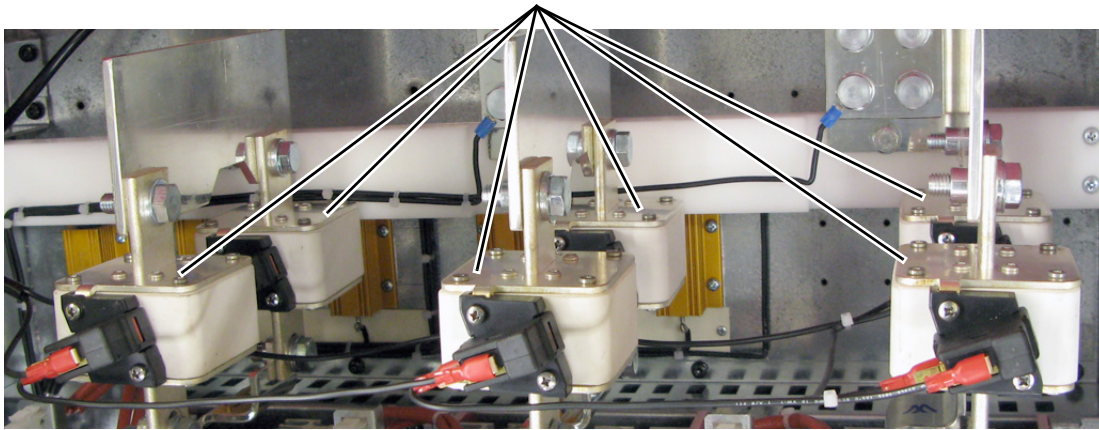

Fuses for Non-Regenerative Frame C and D Drives

AC input line and/or leg fuses are internally mounted and provided with frames C and D drives. See Fuse Code FS4 in PowerFlex DC Drive Frame C and D Fuse Information on page 53. Also, see Frame C Non-Regenerative Drive - AC Input Line Fuse Location on page 58.

AC Input Line Fuses - 230V AC Input Frame C

Frame	Drive Current Rating Code	DC Amps	AC Line Amps	Qty	Bussmann	Mersen	SIBA
					Square Body - Flush End Contact		
C	521	521	426	3	170M5466 + switch 170H0069	6,9 URD 32 TTF 1000 + switch MS 3-V1-5 BS	20 671 32.1000 + switch 28 001 04
	700	700	571				

Leg Fuses - 230V AC Input Frame D Drives

Frame	Drive Current Rating Code	DC Amps	AC Line Amps	Qty	Bussmann	Mersen	SIBA
					Square Body - DIN 43653 Stud-Mount		
D	875	875	715	6	170M6263 + switch 170H0069	Y300263 + switch MS 3V 1-5 UR	20 635 32.900 + switch 28 001 04
	1K0	1050	858				

AC Input Line Fuses - 460V AC Input Frame C

Frame	Drive Current Rating Code	DC Amps	AC Line Amps	Qty	Bussmann	Mersen	SIBA
					Square Body - Flush End Contact		
C	495	495	404.4	3	170M5464 + switch 170H0069	6,9 URD 32 TTF 800 + switch MS 3-V1-5 BS	20 671 32.800 + switch 28 001 04
	667	667	544.9		170M5466 + switch 170H0069	6,9 URD 32 TTF 1000 + switch MS 3-V1-5 BS	20 671 32.1000 + switch 28 001 04

Leg Fuses - 460V AC Input Frame D Drives

Frame	Drive Current Rating Code	DC Amps	AC Line Amps	Qty	Bussmann	Mersen	SIBA
					Square Body - DIN 43653 Stud-Mount		
D	830	830	678.1	6	170M6262 + switch 170H0069	X300262 + switch MS 3V 1-5 UR	20 635 32.800 + switch 28 001 04
	996	996	813.7		170M6264 + switch 170H0069	Z300264 + switch MS 3V 1-5 UR	20 635 32.1000 + switch 28 001 04
	1K1	1162	949.4		170M6265 + switch 170H0069	A300262 + switch MS 3V 1-5 UR	20 635 32.1100 + switch 28 001 04
	1K3	1328	1085.0		170M6266 + switch 170H0069	B300266 + switch MS 3V 1-5 UR	20 635 32.1250 + switch 28 001 04
	1K4	1494	1220.6		170M6267 + switch 170H0069	C300267 + switch MS 3V 1-5 UR	20 635 32.1400 + switch 28 001 04

AC Input Line Fuses - 575V AC Input Frame C Drives

Frame	Drive Current Rating Code	DC Amps	AC Line Amps	Qty	Bussmann	Mersen	SIBA
					Square Body - Flush End Contact		
C	540	540	441	3	170M5466 + switch 170H0069	6,9 URD 32 TTF 1000 + switch MS 3V 1-5 BS	20 671 32.1000 + switch 28 001 04
	675	675	551				

Leg Fuses - 575V AC Input Frame D Drives

Frame	Drive Current Rating Code	DC Amps	AC Line Amps	Qty	Bussmann	Mersen	SIBA
					Square Body - DIN 43653 Stud-Mount		
D	810	810	661	6	170M6262 + switch 170H0069	X300262 + switch MS 3V 1-5 UR	20 635 32.800 + switch 28 001 04
	1K0	1080	881		170M6264 + switch 170H0069	Z300264 + switch MS 3V 1-5 UR	20 635 32.1000 + switch 28 001 04
	1K2	1215	991		170M6265 + switch 170H0069	A300262 + switch MS 3V 1-5 UR	20 635 32.1100 + switch 28 001 04
	1K3	1350	1102		170M6266 + switch 170H0069	B300266 + switch MS 3V 1-5 UR	20 635 32.1250 + switch 28 001 04
	1K6	1688	1377		12	170M6262 + switch 170H0069	X300262 + switch MS 3V 1-5 UR

AC Input Line Fuses - 690V AC Input Frame C Drives

Frame	Drive Current Rating Code	DC Amps	AC Line Amps	Qty	Bussmann	Mersen	SIBA
					Square Body - Flush End Contact		
C	452	452	369	6	170M5463 + switch 170H0069	6,9 URD 32 TTF 0700 + switch MS 3V 1-5 BS	20 671 32.700 + switch 28 001 04
	565	565	461		170M5465 + switch 170H0069	6,9 URD 32 TTF 0900 + switch MS 3V 1-5 BS	20 671 32.900 + switch 28 001 04

Leg Fuses - 690V AC Input Frame D Drives

Frame	Drive Current Rating Code	DC Amps	AC Line Amps	Qty	Bussmann	Mersen	SIBA
					Square Body - DIN 43653 Stud-Mount		
D	678	678	553	6	170M6260 + switch 170H0069	V300260 + switch MS 3V 1-5 UR	20 635 32.630 + switch 28 001 04
	791	791	645		170M6262 + switch 170H0069	X300262 + switch MS 3V 1-5 UR	20 635 32.800 + switch 28 001 04
	904	904	738		170M6263 + switch 170H0069	Y300263 + switch MS 3V 1-5 UR	20 635 32.900 + switch 28 001 04
	1K0	1017	830		170M6264 + switch 170H0069	Z300264 + switch MS 3V 1-5 UR	20 635 32.1000 + switch 28 001 04
	1K1	1130	922		170M6265 + switch 170H0069	A300262 + switch MS 3V 1-5 UR	20 635 32.1100 + switch 28 001 04
	1K2	1243	1014		170M6266 + switch 170H0069	B300266 + switch MS 3V 1-5 UR	20 635 32.1250 + switch 28 001 04
	1K4	1413	1153		170M6267 + switch 170H0069	C300267 + switch MS 3V 1-5 UR	20 635 32.1400 + switch 28 001 04
	1K5	1582	1291		12	170M6262 + switch 170H0069	X300262 + switch MS 3V 1-5 UR

Frame C Non-Regenerative Drive - AC Input Line Fuse Location

AC Input fuses and switches are on the bus bars behind the Control EMI shield, which holds the Control board.

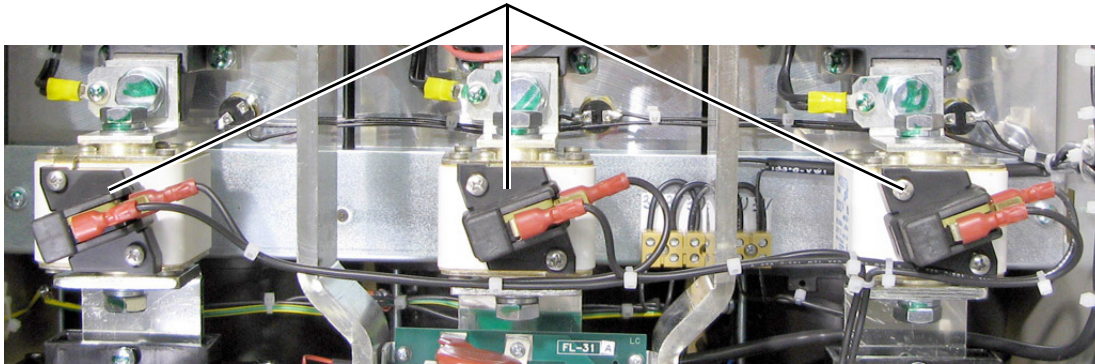

Note: Drive shown with front covers removed and Control EMI shield lowered.

PowerFlex DC Field Controller Input Fuses

Fast-acting AC input fuses are required on all field controllers to help protect the field converter. All AC input fuses must be sourced separately and are mounted externally from the field converter. The required fuses are listed in the following table.

Cat. No.	Frame Size	DC Amps	AC Line Amps	Bussman		Mersen	
				Ferrule FWP Type	North American FWP Type	Ferrule A70QS Type	North American A70P / A70QS Type
23PFCx017	A	17	14	FWP-25A14F	FWP-25B	A70QS25-14F	A70P25-4
23PFCx060		60	49	FWP-80A22F	FWP-80B	A70QS80-22F	A70QS80-4
23PFCx120		120	98	—	FWP-150A	—	A70QS150-4K
23PFCx245	245	201	FWP-300A		A70QS300-4		
23PFCx365	B	365	299		FWP-400A		A70QS400-4
23PFCx570		570	467		FWP-600A		A70QS600-4

PowerFlex DC Drive and Field Controller Control Power Circuit Protection Fuses

The following fuses are used to protect the switching power supply circuit.

IMPORTANT Before you order and install fuses, verify the circuit board revision.

Frame	Circuit Board ID / Revision	Designation	Fuse (5 x 20 mm)
A	SW1-31 / H and below	F1	1 A, 250V, slow
	SW1-31 / I and above		2.5 A, 250V, slow 3.15 A, 250V fast
B	SW2-32 / H and below	F2	2.5 A, 250V slow
	SW2-32 / I and above	F1	
		F2	
C ⁽¹⁾	SW3-32 / H and below	F1	3.15 A, 250V fast
		F2	
	SW3-32 / I and above	F1	2.5 A, 250V slow
		F2	
D ⁽¹⁾	SW1-31 / I and above	F1	

(1) These fuses apply only to PowerFlex DC drives.

Frame A Switching Power Supply Fuse Location (on all PowerFlex DC Drives and Field Controllers)

Top View of Drive

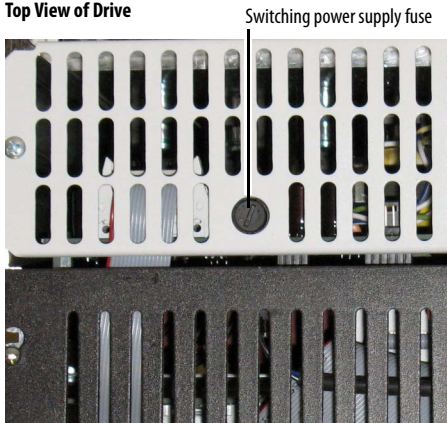

Frame B Switching Power Supply Fuse Location (on all PowerFlex DC Drives and Field Controllers)

Top View of Drive

F1 = 3.15 A fuse
(Board Rev. "H" and below only)

F2 = 2.5 A fuse
(Board Rev. "H" and below only)

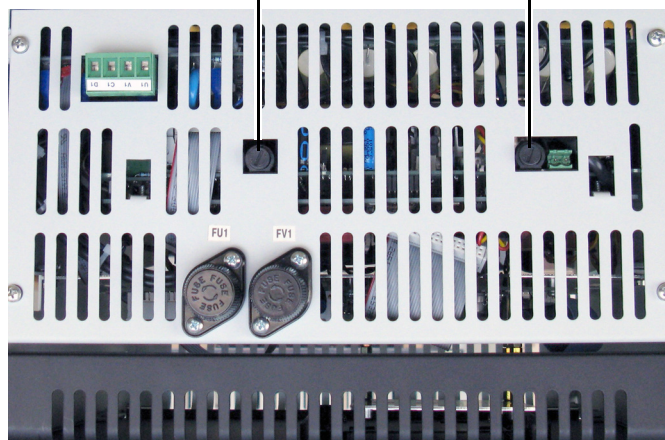

Frame C Switching Power Supply Fuse Location (only on PowerFlex DC Drives)

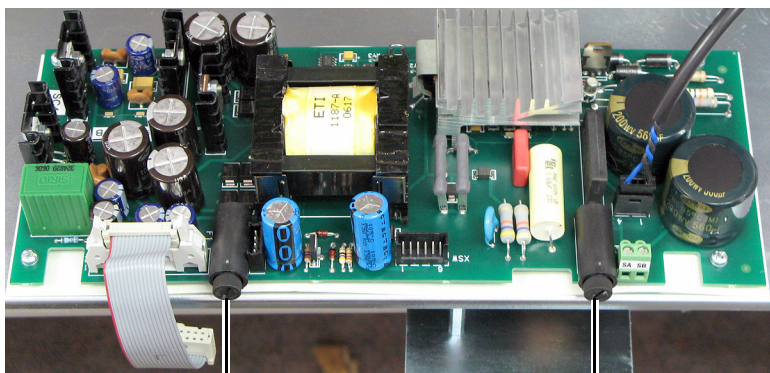

F1 = 3.15 A fuse
(Board Rev. "H" and below only)

F2 = 2.5 A fuse
(Board Rev. "H" and below only)

Fuses are on the switching power supply circuit board (SW-2)
on the back of the control EMI shield, which holds the control board.

Frame D Switching Power Supply Circuit Board Fuse Location (only on PowerFlex DC Drives)

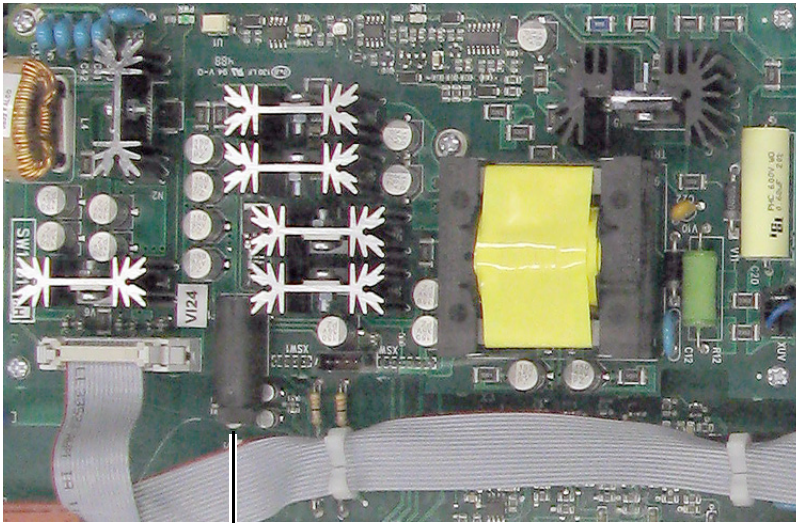

Switching power supply fuse holder

The switching power supply circuit board is on the Control EMI shield.

Mounting

Maximum Surrounding Air Temperature Specifications

- 0...50 °C (32...122 °F), typical
- De-rate 1.25% for every 1 °C (°F) over 50 °C (122 °F), to 55 °C (131 °F)
- Additional cooling is required for temperatures above 55 °C (131 °F)

Operating Conditions

The drive and/or field controller must be mounted in a clean, dry location. Contaminants such as oils, corrosive vapors, and abrasive debris must be kept out of the enclosure. NEMA/UL Type Open, IP20 enclosures are intended for indoor use primarily to provide a degree of protection against contact with enclosed equipment. These enclosures offer no protection against airborne contaminants.

Minimum Mounting Clearances

Minimum clearance requirements (shown here) are intended to be from device to device. Other objects can occupy this space; however, reduced airflow can cause protection circuits to fault the drive. The device must be mounted in a vertical orientation (as shown in the illustration) and must not be mounted at an angle greater than 30° from vertical. In addition, inlet air temperature must not exceed the product specification.

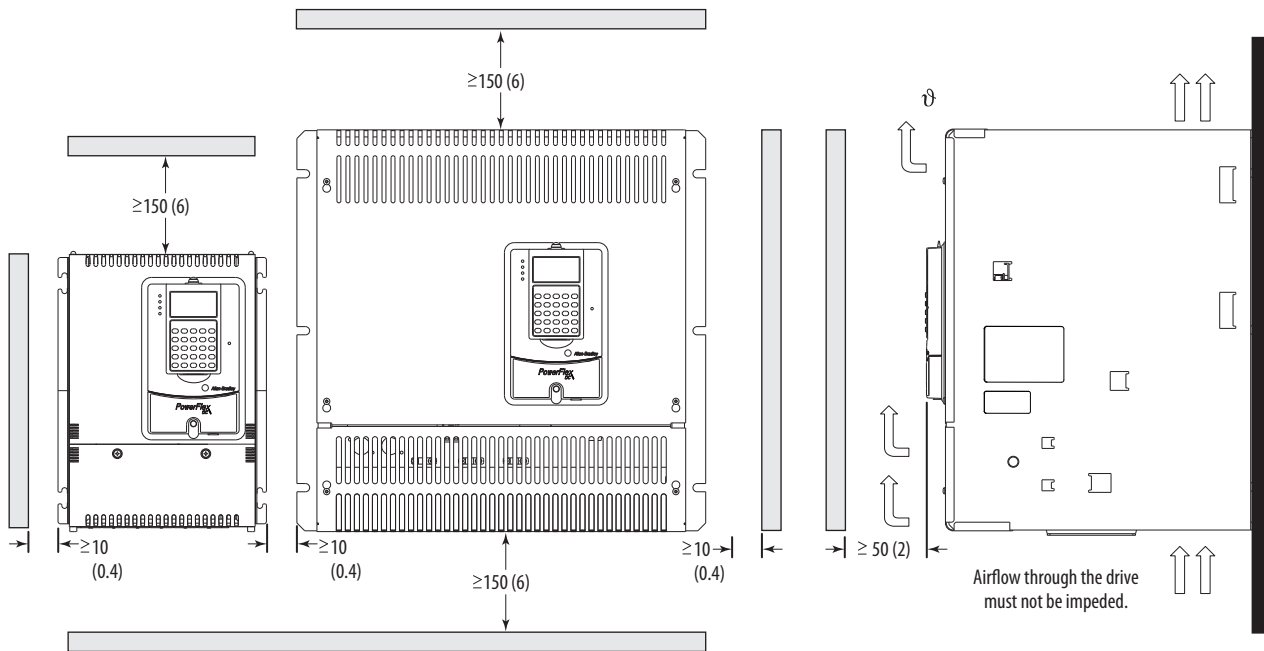

IMPORTANT Verify that all mounting screws are properly tightened before and after operation.

Approximate Dimensions – PowerFlex DC Drives

Frame A Dimensions

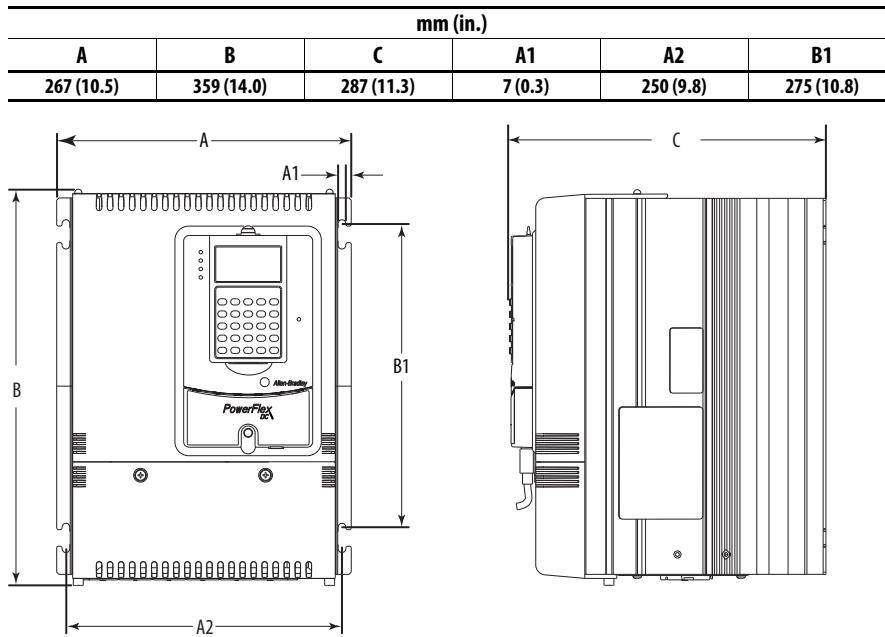

Frame A Weights

Drive w/ND Rating Code		Weight, kg (lb)	
230V	460V	Drive	Drive and Packaging
7P0	4P1	11 (24.25)	13 (28.7)
9P0	6P0		
012	010		
020	014		
—	019		
029	027	11.5 (25.4)	13.5 (29.8)
038	035		
055	045		
—	052	12 (26.5)	14 (30.9)
073	073		
093	086		
110	—		
—	100		
	129		

Approximate Dimensions – PowerFlex DC Drives (continued)

Frame B Dimensions

mm (in.)							
A	A1	A2	A3	B	B1	C1	C2 ⁽¹⁾
311 (12.2)	275 (10.8)	16.5 (0.65)	7 (0.3)	388 (15.3)	375 (14.8)	350 (13.8)	380 (15.0)

(1) Only frame B drive catalog numbers 20P21AD330, 20P21AD412, 20P21AE405, 20P41AB360, 20P41AB434, 20P41AD330, 20P41AD412, and 20P41AE405.

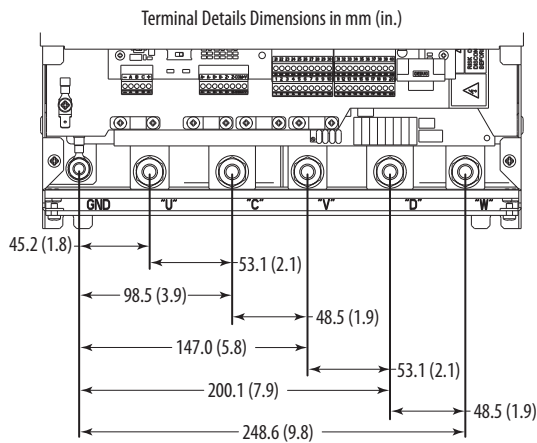
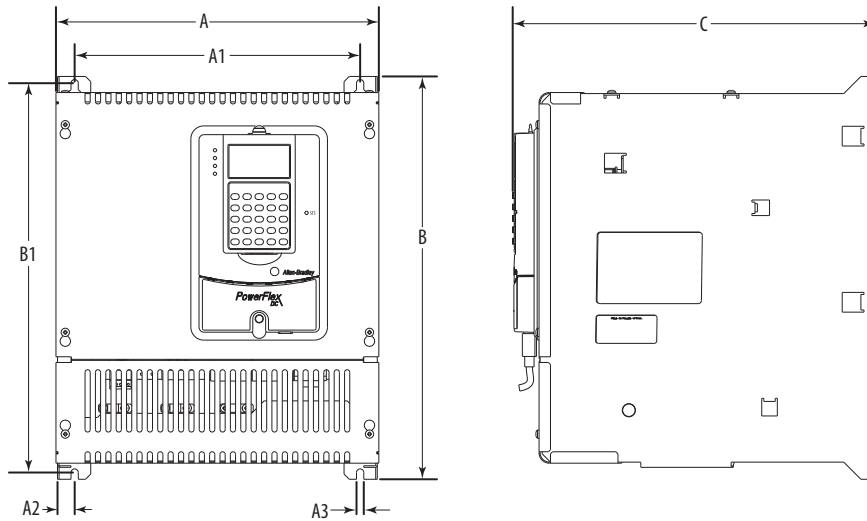

Frame B Weights

Drive w/ND Rating Code			Weight, kg (lb)	
230V	460V	575V	Drive	Drive and Packaging
146	167	067	25.5 (56.2)	27.5 (60.6)
180	207	101		
218	—	135		
265	250	270	29.5 (65.0)	31.5 (69.5)
360	330	405	32 (70.5)	34 (75)
434	412	—		

Approximate Dimensions – PowerFlex DC Drives (continued)

Frame C Dimensions

mm (in.)								
A	A1	B	B1	B2	B3	B4	B5	C
521 (20.5)	499 (19.7)	511 (20.1)	400 (15.7)	200 (7.9)	55 (2.2)	56 (2.2)	10.5 (0.4)	416 (16.4)

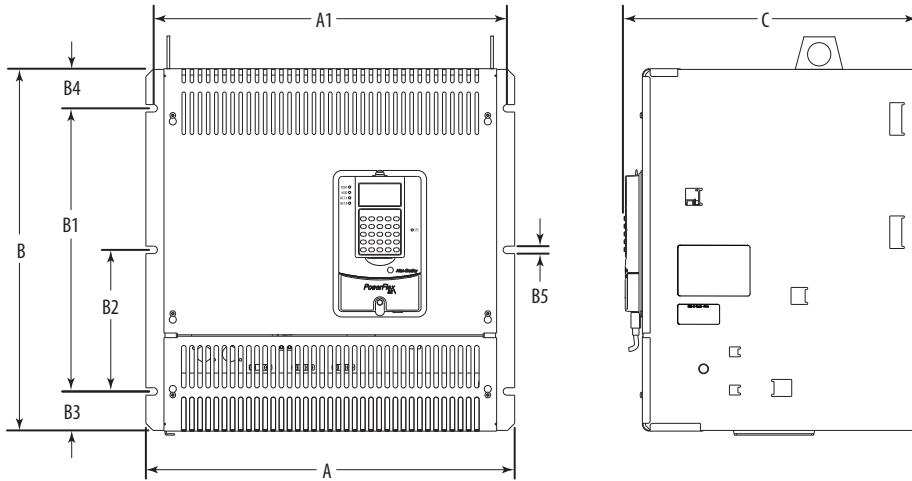

Terminal dimensions are shown in mm and (in.)

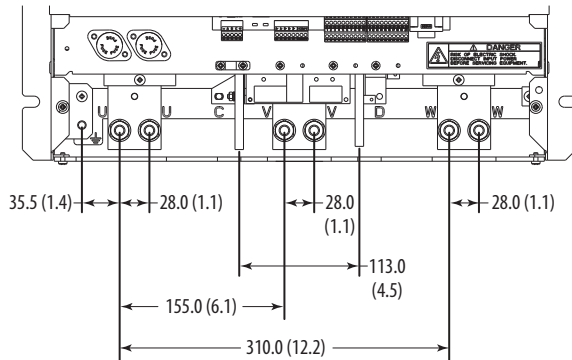

Frame C Weights

Drive w/ND Rating Code				Weight, kg (lb)			
				Regenerative Drives		Non-regenerative Drives	
230V	460V	575V	690V	Drive	Drive and Packaging	Drive	Drive and Packaging
—	495	—		61 (134.5)	83 (183.0)	57 (125.7)	79 (174.2)
521	667			65 (143.3)	87 (191.8)	62 (136.7)	84 (185.2)
700	—			72 (158.7)	94 (207.2)	68 (150.0)	90 (198.4)
—	—	540	452				
		675	565				

Approximate Dimensions – PowerFlex DC Drives (continued)

Frame D Dimensions - Right Side and Front Views

Dimensions are shown in mm and (in.)

Dimensions of terminals U, V, and W are the same.

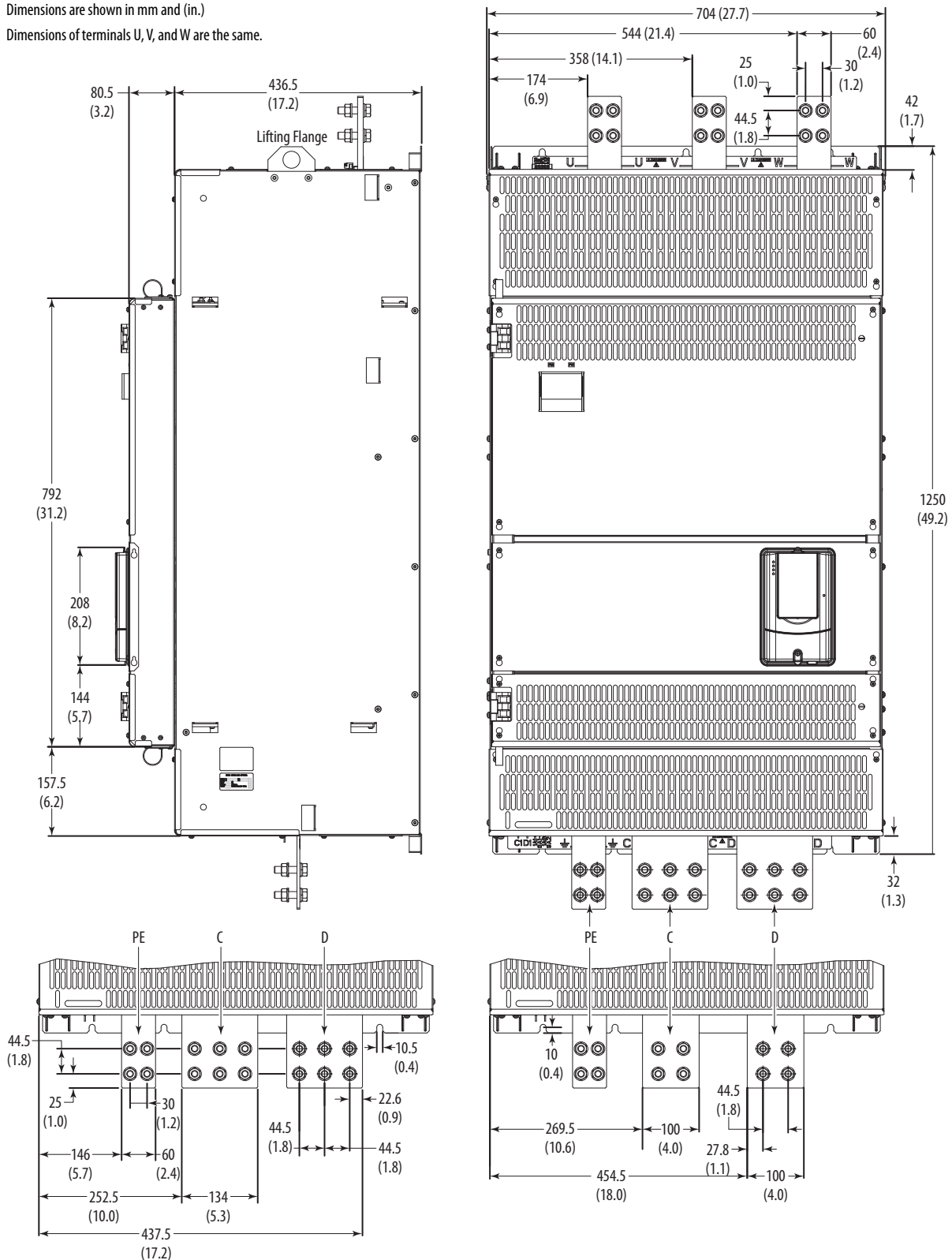

134 mm (5.3 in.) C and D terminals are installed on 460V AC input, 800 Hp and 900 Hp, 575V AC input, 1000 Hp, and 690V AC input, 1100, 1200, 1250, and 1,400 Hp drives only. All other frame D ratings have 100 mm (4.0 in.) C and D terminals.

Approximate Dimensions – PowerFlex DC Drives (continued)

Frame D Dimensions - Left Side and Back Views

Dimensions are shown in mm and (in.)

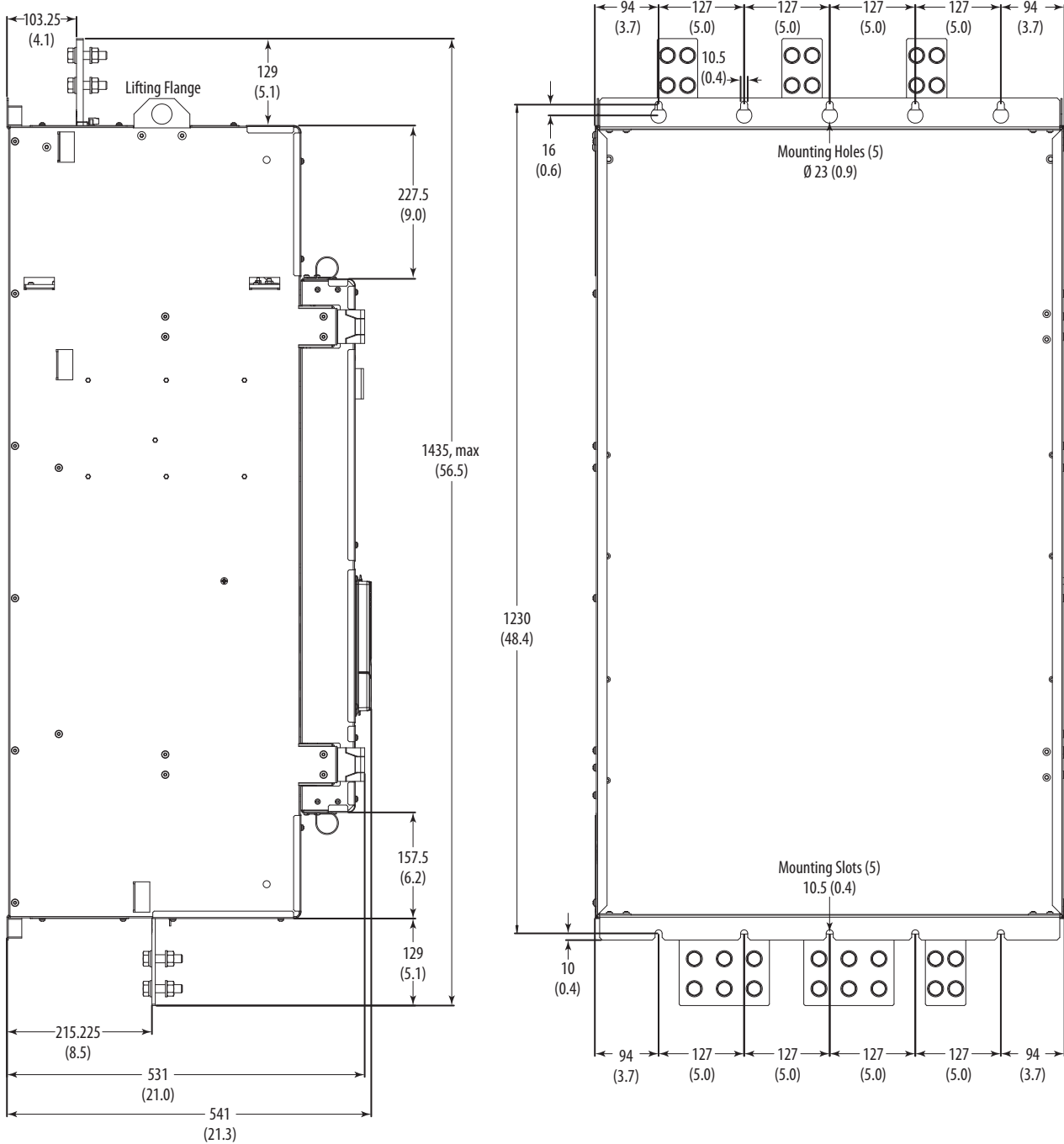

Frame D - 230V AC Input Drive Weights

Drive w/ND Rating Code	Weight, kg (lb)			
	Regenerative Drives		Non-regenerative Drives	
	Drive	Drive and Packaging	Drive	Drive and Packaging
875	203 (447.5)	281 (619.5)	152 (335.1)	230 (507.1)
1K0				

Frame D - 460V AC Input Drive Weights

Drive w/ND Rating Code	Weight, kg (lb)			
	Regenerative Drives		Non-regenerative Drives	
	Drive	Drive and Packaging	Drive	Drive and Packaging
830	202 (445.3)	280 (617.3)	152 (335.1)	230 (507.1)
996				
1K1	215 (474.0)	293 (646.0)	165 (363.8)	243 (535.7)
1K3				
1K4				

Frame D - 575V AC Input Drive Weights

Drive w/ND Rating Code	Weight, kg (lb)			
	Regenerative Drives		Non-regenerative Drives	
	Drive	Drive and Packaging	Drive	Drive and Packaging
810	198 (436.5)	276 (608.5)	148 (326.3)	226 (498.2)
1K0				
1K2	215 (474.0)	293 (646.0)	165 (363.8)	243 (535.7)
1K3	222 (489.4)	300 (661.4)	172 (379.2)	250 (551.2)
1K6	241 (531.3)	319 (703.3)	191 (421.1)	269 (593.0)

Frame D - 690V AC Input Drive Weights

Drive w/ND Rating Code	Weight, kg (lb)			
	Regenerative Drives		Non-regenerative Drives	
	Drive	Drive and Packaging	Drive	Drive and Packaging
678	198 (436.5)	276 (608.5)	148 (326.3)	226 (498.2)
791				
904	200 (440.9)	278 (612.9)	150 (330.7)	228 (502.7)
1K0	202 (445.3)	280 (617.3)	152 (335.1)	230 (507.1)
1K1	215 (474.0)	293 (646.0)		
1K2			165 (363.8)	243 (535.7)
1K4	241 (531.3)	319 (703.3)	172 (379.2)	250 (551.2)
1K5			191 (421.1)	269 (593.0)

Approximate Dimensions and Weights – PowerFlex DC Field Controllers

Frame A Dimensions

mm (in.)					
A	B	C	A1	A2	B1
267 (10.5)	359 (14.0)	287 (11.3)	7 (0.3)	250 (9.8)	275 (10.8)

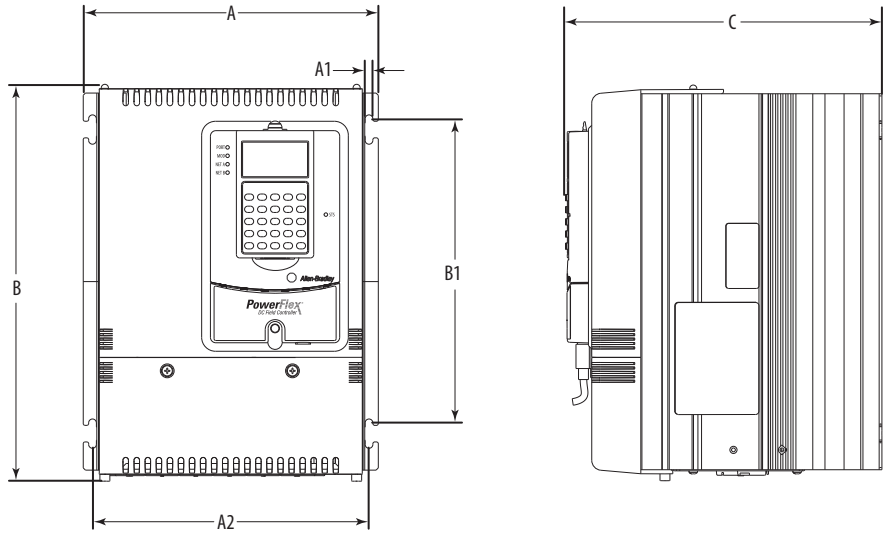

Frame A Weights

Cat. No.	Weight, kg (lb)	
	Drive	Drive and Packaging
23PFCB017 and 23PFCD017	10.8 (23.8)	12.8 (28.2)
23PFCB060 and 23PFCD060	11.3 (24.9)	13.3 (29.3)
23PFCB120 and 23PFCD120	11.8 (26.0)	13.8 (30.4)

Approximate Dimensions and Weights – PowerFlex DC Field Controllers (continued)

Frame B Dimensions

mm (in.)							
A	A1	A2	A3	B	B1	C1	C2 ⁽¹⁾
311 (12.2)	275 (10.8)	16.5 (0.65)	7 (0.3)	388 (15.3)	375 (14.8)	350 (13.8)	380 (15.0)

(1) Only frame B drive catalog numbers 23PFCB570 and 23PFCD570.

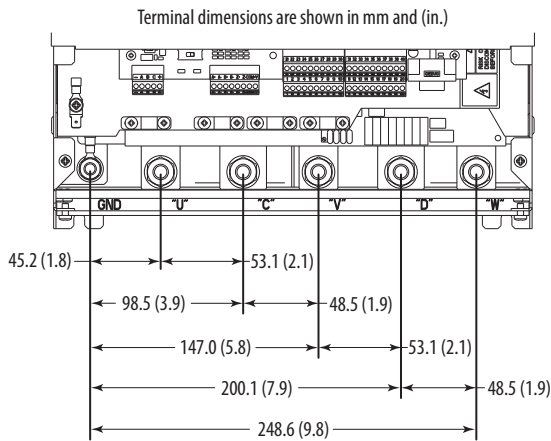
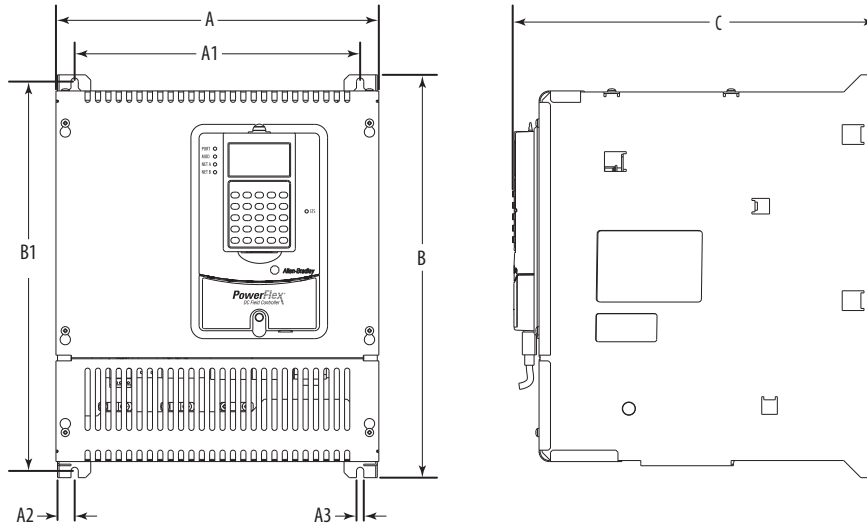

Frame B Weights

Cat. No.	Weight, kg (lb)	
	Drive	Drive and Packaging
23PFCB245 and 23PFCD245	25.3 (55.8)	27.3 (60.2)
23PFCB365 and 23PFCD365	29.3 (64.6)	31.3 (69.0)
23PFCB570 and 23PFCD570	31.8 (70.1)	33.8 (74.5)

PowerFlex DC Drive Specifications

Category	Specification	
Agency Certification	c-UL-us	Listed to UL508C and CAN/CSA C22.2 No. 14-05.
	CE	In conformity with the following European Directives: <ul style="list-style-type: none"> • EMC Directive (2014/35/EU) • Low Voltage Directive (2006/95/EC) Standards applied: <ul style="list-style-type: none"> • EN 61800-5-1 • EN 61800-3
	RCM	Certified by Rockwell Automation to be in conformity with the requirements of the applicable Australian legislation and the standards referenced: IEC 61800-3.
	Korean KC Registration	MSIP-REM-RAA-20P See the certificate of registration for specific drive catalog numbers that have this certification. ⁽¹⁾
	The drive is also designed to meet the following specifications: NFPA 70 – US National Electrical Code	

(1) See the product certifications website, <http://www.rockwellautomation.com/products/certification/> for declarations of conformity, certificates, and other certification details.

Category	Specification	
Drive Type	Full Wave Regen, 6 Pulse, Regulated Field Supply	
Protection	Heat sink Thermistor:	Monitored by microprocessor overtemp trip
	Drive Overcurrent Trip	<ul style="list-style-type: none"> • Programmable, 0...250% of rated current (175% default) • Based on armature circuit fusing
	<ul style="list-style-type: none"> • Software Overcurrent Trip: • Hardware Overcurrent Trip: 	
	Line transients:	Up to 2,000 volts peak per IEC 6100-4-5
	Control Logic Noise Immunity:	Showering arc transients up to 1500V peak
	Power Ride-Thru:	15 milliseconds at full load
Environment ⁽¹⁾	Logic Control Ride-Thru:	0.5 seconds minimum, 2 seconds typical
	Altitude:	1,000 m (3,300 ft) max. without derating. De-rate output power by 1.2% for every 100 meters (328 ft) above 1,000 meters (3,300 ft).
	Maximum Surrounding Air Temperature IP20, NEMA Type Open:	0...50 °C (32...122 °F), typical. De-rate 1.25% for every 1 °C over 50 °C (122 °F), to 55 °C (131 °F). More cooling is required for temps. above 55 °C.
	Storage Temp. (all const.):	-25...55 °C (-13...131 °F)
	Atmosphere:	Important: Drive must not be installed in an area where the ambient atmosphere contains volatile or corrosive gas, vapors, or dust. If the drive is not going to be immediately installed, it must be stored in an area where it is not exposed to a corrosive atmosphere.
	Relative Humidity:	Operating: 5...85% noncondensing Storage: 5...95% noncondensing
	Shock:	15G peak for 11 ms duration (±1.0 ms)
Vibration:	0.152 mm (0.006 in.) displacement, 1G peak	

(1) PowerFlex DC drives must be installed in a Pollution Degree 2 environment.

PowerFlex DC Drive Specifications (continued)

Category	Specification		
Drive Type	Full Wave Regen, 6 Pulse, Regulated Field Supply		
Electrical	Input Voltages:	Armature: 230V to 690V AC +/- 10%, 3 Phase Field: 230V to 460V AC +/- 10%, 1 Phase Control: 115V AC or 230V AC +/- 15%, 1 Phase (115V AC input control power requires a jumper between terminals SA and SB for frame B and C drives only.) (See AC Input Voltages on page 22 for details.)	
	Input Frequency:	50/60 Hz +/- 5%	
	Max. Rate of Change of Input Frequency:	2 Hz/Sec.	
	Armature Output Voltage:	Two Quadrant Drives	Four Quadrant Drives
		260V DC @ 230V AC	240V DC @ 230V AC
		470V DC @ 400V AC	420V DC @ 400V AC
		530V DC @ 440V AC	460V DC @ 440V AC
		560V DC @ 460V AC	480V DC @ 460V AC
		580V DC @ 480V AC	500V DC @ 480V AC
		680V DC @ 575V AC	600V DC @ 575V AC
		810V DC @ 690V AC	720V DC @ 690V AC
	Output Horsepower (Cont.)	1.5...300 Hp @ 230V AC 2...900 Hp @ 460V AC 50...1250 Hp @ 575V AC 400...1400 Hp @ 690V AC	
Output Current:	7...1050 A @ 230V AC 4.1...1494 A @ 400V AC 67.5...1688 A @ 575V AC 452...1582 A @ 690V AC		
Drive Overload Capability:	100% rated continuous current 150% rated current for 1 minute then fault 200% rated current for 3 seconds then fault		
Motor Overload Protection:	Standard Duty: <ul style="list-style-type: none"> 150% motor rated current for 60 seconds 200% motor rated current for 3 seconds, configurable as a fault or alarm Heavy Duty: <ul style="list-style-type: none"> 200% motor rated current for 60 seconds, configurable as a fault or alarm Note: PowerFlex DC drives, v6.xxx and later, provide configurable speed-sensitive overload protection, thermal memory retention, and motor over-temperature sensing.		
Field Output Voltage	200V DC @ 230V AC 310V DC @ 400V AC 360V DC @ 460V AC Maximum field output voltage is 0.85 x AC input line voltage.		
Controller Current Overload:	150% rated current for 1 minute 200% rated current for 3 seconds		
Max. Short Circuit Rating:	100,000 A		

PowerFlex DC Drive Specifications (continued)

Category	Specification	
Control	Speed Regulation: ⁽¹⁾	All operating modes: Max. speed: 8,000 rpm Digital reference resolution: 0.1 rpm Analog reference resolution: ≥ 0.25 rpm
		with Digital Incremental Encoder/Resolver Speed feedback resolution better than 0.5 rpm (based on encoder PPR or resolver resolution) Operating range better than 1000:1 rpm, bidirectional Performance Accuracy $\pm 0.02\%$ typical 170 rad/sec bandwidth
		with DC Analog Tachometer Speed feedback resolution better than 2000:1 rpm Operating range better than 1000:1 rpm, bidirectional Performance accuracy $\pm 0.1\%$ 170 rad/sec bandwidth
		with Armature Voltage Feedback Voltage feedback resolution better than 2000:1 rpm Operating range better than 100:1 rpm, bidirectional Performance accuracy: $\pm 2.0\%$ typical 80 rad/sec bandwidth
Feedback Devices	Torque Regulation	Current feedback resolution better than 2000:1 Performance accuracy: 1.0% typical 500 rad/sec bandwidth
	Encoder	Type: Incremental, dual channel, two channel optional (with jumper), differential (recommended) or single-ended Input Voltage: Configurable for 2.5 . . . 5.2V (switch S21 in ENC_5 position) or 5.4 . . . 15.2V (switch S21 in ENC_12 position) Input Current: 4.5 mA / 6.8 . . . 10.9 mA each channel Quadrature: $90^\circ \pm 27^\circ @ 25^\circ\text{C}$ Duty cycle: $50\% \pm 10\%$ Source/Sink capable Pulses Per Revolution: 100 . . . 32770 Maximum Frequency: 150 kHz Maximum Cable Length: Shielded, 150 m (0.75 mm ²), 125 m (0.5 mm ²), 55 m (0.22 mm ²)
	Resolver	See the PowerFlex DC Drive Resolver Feedback Option Module Installation Instructions, publication 20P-IN071 for details.
	DC Analog Tachometer	Input Voltage: 22.7, 45.4, 90.7, 181.6, & 302.9V max. Input Current: 8 mA full scale Maximum Cable Length: Shielded, depends on the installation, typical 150 m.
Inputs	Analog Inputs	Three configurable, isolated, differential $\pm 10\text{V}$, 0 . . . 10V, 0 . . . 20 mA or 4 . . . 20 mA. Resolution: 11 Bit + sign
	Digital Inputs	Eight standard configurable, four additional configurable with the I/O Expansion circuit board. Max Voltage +30V DC input, 200 mA (total current draw is the sum of encoder power, digital outputs, and any other loads that are connected to terminal 19)
Outputs	Analog Outputs	Two standard configurable, two additional configurable with the I/O Expansion circuit board. Sample rate 2 ms. $\pm 10\text{V}$, 5 mA, bipolar (current is not bipolar) Resolution: 11 Bit + sign
	Digital Outputs	Four standard configurable, four additional configurable with the I/O Expansion circuit board. 30V, 50 mA
	Relay Outputs	Two configurable, N.O. contacts Max. 250V AC, 1 A AC1

(1) Subject to motor specs. and current loop tuning.

PowerFlex DC Field Controller Specifications

Category	Specification	
Agency Certification	c-UL-us	Listed to UL508C and CAN/CSA C22.2 No. 14-05.
	CE	In conformity with the following European Directives: <ul style="list-style-type: none"> EMC Directive (2004/108/EC) Low Voltage Directive (2006/95/EC) Standards applied: <ul style="list-style-type: none"> EN 50178 EN 61800-3
	RCM	Certified by Rockwell Automation to be in conformity with the requirements of the applicable Australian legislation and the standards referenced: IEC 61800-3.
	Korean KC Registration	MSIP-REM-RAA-20P See the certificate of registration for specific drive catalog numbers that have this certification. ⁽¹⁾
	The drive is also designed to meet the following specifications: NFPA 70 - US National Electrical Code	

(1) See the product certifications website, <http://www.rockwellautomation.com/rockwellautomation/certification/overview.page> for declarations of conformity, certificates, and other certification details.

Category	Specification	
Drive Type	Full Wave Regen, 6 Pulse, Regulated Field Supply	
Protection	Heat sink Thermistor:	Monitored by microprocessor overtemp trip
	Drive Overcurrent Trip	Programmable, 0...250% of rated current (175% default)
	Line transients	Up to 2,000 volts peak per IEC 6100-4-5
	Control Logic Noise Immunity	Showering arc transients up to 1500V peak
	Power Ride-Thru	15 milliseconds at full load
	Logic Control Ride-Thru	0.5 seconds minimum, 2 seconds typical
Environment ⁽¹⁾	Altitude:	1,000 m (3,300 ft) max. without derating. De-rate output power by 1.2% for every 100 meters (328 ft) above 1,000 meters (3,300 ft).
	Maximum Surrounding Air Temperature IP20, NEMA Type Open:	0...50 °C (32...122 °F), typical. De-rate 1.25% for every 1 °C over 50 °C (122 °F), to 55 °C (131 °F). More cooling is required for temps. above 55 °C.
	Storage Temp. (all const.)	-25...+55 °C (-13...+131 °F)
	Atmosphere	Important: The field controller must not be installed in an area where the ambient atmosphere contains volatile or corrosive gas, vapors, or dust. If the drive is not going to be immediately installed, it must be stored in an area where it is not exposed to a corrosive atmosphere.
	Relative Humidity	Operating: 5...85% noncondensing Storage: 5...95% noncondensing
	Shock	15G peak for 11 ms duration (°1.0 ms)
	Vibration	0.152 mm (0.006 in.) displacement, 1G peak
Electrical	Input Voltages:	Control: 115V AC or 230V AC +/- 15%, 1 Phase (For details, see AC Input Voltages on page 22.)
	Input Frequency:	50/60 Hz +/- 5%
	Max. Rate of Change of Input Frequency:	2 Hz/Sec.
	Output Current:	17...570 A
	Drive Overload Capability:	100% rated continuous current
	Field Output Voltage	Maximum field output voltage is 1.16 x AC input line voltage.
	Max. Short Circuit Rating:	100,000 A

(1) Field controllers must be installed in a Pollution Degree 2 environment.

(2) 115V AC input control power requires a jumper between terminals SA and SB for frame B field controllers only. For more information, see [PowerFlex DC Drives and Field Controller Control Circuit Input Power on page 34.](#)

PowerFlex DC Field Controller Specifications (continued)

Category	Specification	
Inputs	Analog Inputs	Three configurable, isolated, differential ±10V, 0...10V, 0...20 mA or 4...20 mA. Resolution: 11 Bit + sign
	Digital Inputs	Eight standard configurable, four additional configurable with the I/O Expansion circuit board. Max Voltage +30V DC input, 200 mA (total current draw is the sum of encoder power, digital outputs, and any other loads that are connected to terminal 19)
Outputs	Analog Outputs	Two standard configurable, two additional configurable with the I/O Expansion circuit board. Sample rate 2 ms. ±10V, 5 mA, bipolar (current is not bipolar) Resolution: 11 Bit + sign
	Digital Outputs	Four standard configurable, four additional configurable with the I/O Expansion circuit board. 30V, 50 mA
	Relay Outputs	Two configurable, N.O. contacts Max. 250V AC, 1 A AC1

IP20 NEMA/UL Type Open Watts Loss

Watts loss and cooling fan attributes data that are shown in the following tables is based on the rated current of the drive.

PowerFlex DC Drives, Frame A

Drive Current Rating Code ⁽¹⁾		Total Watts Loss	Total Value for Fan									
@ 230V AC	@ 460V AC		AC Input Voltage	Rated Current (A)	Max. Airflow Noise Level							
7P0	4P1	131	(No fan)									
9P0	6P0											
012	010											
020	014											
—	019											
029	027	186	(Internal power supply)									
038	035	254						80 m ³ /h 37 dB(A)				
055	045											
—	052											
073	073	408										
093	086											
110	—											
—	100	553										160 m ³ /h 45 dB(A)
—	129											

(1) See [PowerFlex DC Drive Catalog Number Explanation on page 6](#), positions 8...10 for corresponding drive Hp rating, armature Amp rating, and field Amp rating.

PowerFlex DC Drives, Frame B

Drive			Total Value for Fans		
Current Rating Code ⁽¹⁾	AC Input Voltage	Total Watts Loss	AC Input Voltage	Rated Current (A)	Max. Airflow Noise Level
146	230	781	(Internal power supply)		320 m ³ /h 48 dB(A)
180		939			
218		1038			
265		1693			
360					
434					
167	460	781			320 m ³ /h 48 dB(A)
207		939			
250		1038			
330		1248			
412		1693			
067	575	400			680 m ³ /h 53 dB(A)
101		553			
135		700			
270		1038			
405		1693			

(1) See [PowerFlex DC Drive Catalog Number Explanation on page 6](#), positions 8...10 for corresponding drive Hp rating, armature Amp rating, and field Amp rating.

PowerFlex DC Drives, Frame C

Drive			Total Value for Fans ⁽²⁾		
Current Rating Code ⁽¹⁾	AC Input Voltage	Total Watts Loss	AC Input Voltage	Rated Current	Max. Airflow Noise Level
521	230	2143	230V AC	0.75 A	1,050 m ³ /h 62.5 dB(A)
700		2700			
495	460	2143			
667		2590			
540		2300			
675	575	2620			
452	690	1700			
565		2300			

(1) See [PowerFlex DC Drive Catalog Number Explanation on page 6](#), positions 8...10 for corresponding drive Hp rating, armature Amp rating, and field Amp rating.

(2) Fans on frames C drives must be powered by an external 230V AC, 50/60 Hz power supply, which is connected to terminals U3 and V3.

PowerFlex DC Drives, Frame D

Drive			Total Value for Fans								
			With Series A Fan ⁽²⁾			With Series B Fan ⁽³⁾			With Series C Fan ⁽³⁾		
Current Rating Code ⁽¹⁾	AC Input Voltage	Total Watts Loss	AC Input Voltage	Rated Current	Max. Airflow Noise Level	AC Input Voltage	Rated Current	Max. Airflow Noise Level	AC Input Voltage	Rated Current	Max. Airflow Noise Level
875	230	2694	230V AC	2.4 A @ 50 Hz and 3.3 A @ 60 Hz	2,400 m ³ /h 80 dB(A)	Three-phase 400V AC 50 Hz or 460V AC 60 Hz	1.15 A @ 50 Hz and 1.4 A @ 60 Hz	2,400 m ³ /h @ 400VAC 50 Hz 2,800 m ³ /h @ 460VAC 60 Hz 83 dB(A) @ 400VAC 50 Hz 2,000 m ³ /h 86 dB(A) @ 460VAC 60 Hz 2,000 m ³ /h	Three-phase 400V AC 50 Hz or 460V AC 60 Hz	1.25 A @ 50 Hz and 1.55 A @ 60 Hz	2,900 m ³ /h @ 400VAC 50 Hz 3,400 m ³ /h @ 460VAC 60 Hz 84 dB(A) @ 400VAC 50 Hz 90 dB(A) @ 460VAC 60 Hz
1K0		3284									
830	480	3200									
996		3568									
1K1		4189									
1K3		5229									
1K4		5117									
810	575	3122									
1K0		3819									
1K2		4679									
1K3		4879									
1K6		5720									
678		3174									
791		3582									
904	690	4028									
1K0		4064									
1K1		4509									
1K2		5368									
1K4		5543									
1K5		5886									

- (1) See [PowerFlex DC Drive Catalog Number Explanation on page 6](#), positions 8...10 for corresponding drive Hp rating, armature Amp rating, and field Amp rating.
- (2) Series A fans on frame D drives are powered by an external 230V AC, 50/60 Hz power supply, which is connected to terminals U3 and V3.
- (3) Series B and Series C fans on frame D drives are powered by an external three-phase 400/460V AC, 50/60 Hz power supply, which is connected to terminals U3, V3, and W3.

PowerFlex DC Field Controller

Frame Size	DC Output, Amps	Total Watts Loss	Total Value for Fans		
			AC Input Voltage	Rated Current	Max. Airflow Noise Level
A	17	131	(No fan)		
	60	254	(Internal power supply)	80 m ³ /h 37 dB(A)	
	120	476		160 m ³ /h 45 dB(A)	
B	245	781		320 m ³ /h 48 dB(A)	
	365	1038		680 m ³ /h 53 dB(A)	
	570	1693			

PowerFlex DC Standalone Regulator

Catalog Number ⁽¹⁾	Total Watts Loss	Total Value for Fans		
		AC Input Voltage	Rated Current	Max. Airflow Noise Level
23PMD4	303	(Internal power supply)	160 m ³ /h 40 dB(A)	
23PMD7	357			
23PMF4	374			
23PMF7	428			

- (1) For a description of ratings, see catalog numbers in the PowerFlex DC Standalone Regulator and Gate Amplifier User Manual, publication [23P-UM001](#).

Notes:

Notes:

Notes:

Rockwell Automation Support

Use the following resources to access support information.

Technical Support Center	Knowledgebase Articles, How-to Videos, FAQs, Chat, User Forums, and Product Notification Updates.	www.rockwellautomation.com/knowledgebase
Local Technical Support Phone Numbers	Locate the phone number for your country.	www.rockwellautomation.com/global/support/get-support-now.page
Direct Dial Codes	Find the Direct Dial Code for your product. Use the code to route your call directly to a technical support engineer.	www.rockwellautomation.com/global/support/direct-dial.page
Literature Library	Installation Instructions, Manuals, Brochures, and Technical Data.	www.rockwellautomation.com/literature
Product Compatibility and Download Center (PCDC)	Get help determining how products interact, check features and capabilities, and find associated firmware.	www.rockwellautomation.com/global/support/pcdc.page

Documentation Feedback

Your comments will help us serve your documentation needs better. If you have any suggestions on how to improve this document, complete the How Are We Doing? form at http://literature.rockwellautomation.com/idc/groups/literature/documents/du/ra-du002_-en-e.pdf.

Rockwell Automation maintains current product environmental information on its website at <http://www.rockwellautomation.com/rockwellautomation/about-us/sustainability-ethics/product-environmental-compliance.page>.

Allen-Bradley, Compact I/O, Connected Components Workbench, DPI, DriveTools, LISTEN. THINK. SOLVE, PanelView, PowerFlex, Rockwell Automation, Rockwell Software, Studio 5000, and TorqProve are trademarks of Rockwell Automation, Inc.

Trademarks not belonging to Rockwell Automation are property of their respective companies.

Rockwell Otomasyon Ticaret A.Ş., Kar Plaza İş Merkezi E Blok Kat:6 34752 İçerenköy, İstanbul, Tel: +90 (216) 5698400

www.rockwellautomation.com

Power, Control and Information Solutions Headquarters

Americas: Rockwell Automation, 1201 South Second Street, Milwaukee, WI 53204-2496 USA, Tel: (1) 414.382.2000, Fax: (1) 414.382.4444

Europe/Middle East/Africa: Rockwell Automation NV, Pegasus Park, De Kleetlaan 12a, 1831 Diegem, Belgium, Tel: (32) 2 663 0600, Fax: (32) 2 663 0640

Asia Pacific: Rockwell Automation, Level 14, Core F, Cyberport 3, 100 Cyberport Road, Hong Kong, Tel: (852) 2887 4788, Fax: (852) 2508 1846

Publication 20P-TD001J-EN-P - December 2018

Supersedes Publication 20P-TD001I-EN-P - December 2017

Copyright © 2018 Rockwell Automation, Inc. All rights reserved. Printed in the U.S.A.